

Manta

G-2460



- Sony IMX540 CMOS sensor
- Power over Ethernet option
- Angled-head and board level variants
- Video-iris lens control

GigE Vision camera with the Sony IMX540 CMOS sensor

Manta G-2460 is a 24.6 megapixel machine vision camera with a GigE compliant Gigabit Ethernet port and Hirose I/O port. Manta G-2460 incorporates the high quality Type 1.2 (19.3 mm diagonal) Sony fourth generation IMX540 back-illuminated CMOS sensor with Pregius S global shutter technology. At full resolution, this camera runs 4.9 frames per second. With a smaller region of interest, higher frame rates are possible.

Providing the largest choice of sensors and an advanced feature set, Manta is Allied Vision's most versatile GigE Vision camera series. Numerous modular options, including angled head and board level versions facilitate the camera integration in almost any application. Manta's advanced feature set simplifies multi-camera applications, reduces the need for cabling, and keeps your costs low. By default monochrome models ship with B 270 protection glass and color models ship with a Type Hoya C-5000 IR cut filter.

Benefits and features

- Monochrome (G-2460B) and color (G-2460C) models
- GigE Vision interface with Power over Ethernet option
- Screw mount RJ45 Ethernet connector for secure operation in industrial environments
- Supports cable lengths up to 100 meters (CAT-6 recommended)
- Trigger over Ethernet Action Commands allow for a single cable solution to reduce system costs
- Comprehensive I/O functionality for simplified system integration
- Popular C-Mount lens mount
- Easy camera mounting via standard M3 threads on top and bottom of housing or optional tripod adapter
- Easy software integration with Allied Vision's [Vimba Suite](#) and compatibility to the most popular [third party image-processing libraries](#).

Hardware options

- Various housing options: Select between standard housing, angled-head, or board level versions
- Various lens mounts: Select between C-Mount, CS-Mount, or M12-Mount (adapter)
- Various optical filters: Select between B 270 ASG protection glass and filter types: Jenofilt 217 IR cut filter, Hoya C-5000 IR cut filter, RG715 IR pass filter, or RG830 IR pass filter.
- Available with Power over Ethernet compliant interface
- White medical design housing option

See the [Modular Concept](#) for lens mount, housing variants, optical filters, case design, and other modular options. See the [Customization and OEM Solutions](#) webpage for additional options.

Specifications

Manta	G-2460
Interface	IEEE 802.3 1000BASE-T, IEEE 802.3af (PoE) optional
Resolution	5328 (H) × 4608 (V)
Spectral range	300 to 1100 nm
Sensor	Sony IMX540
Sensor type	CMOS
Shutter mode	Global shutter
Sensor size	Type 1.2
Pixel size	2.74 μm × 2.74 μm
Lens mounts (available)	C-Mount, CS-Mount, S-Mount
Max. frame rate at full resolution	4.9 fps
ADC	12 Bit
Image buffer (RAM)	128 MByte

Imaging performance

Imaging performance data is based on the evaluation methods in the EMVA 1288 Release 3.1 standard for characterization of image sensors and cameras. Measurements are typical values for monochrome models measured at full resolution without optical filter. Contact Sales or AE for more information.

Quantum efficiency at 529 nm	70 %
Temporal dark noise	2.2 e ⁻
Saturation capacity	9300 e ⁻
Dynamic range	70.5 dB
Absolute sensitivity threshold	2.8 e ⁻

Output

Bit depth	8/12 Bit
Monochrome pixel formats	Mono8, Mono12Packed, Mono12
YUV color pixel formats	YUV411Packed, YUV422Packed, YUV444Packed

Manta	G-2460
RGB color pixel formats	RGB8Packed, BGR8Packed
Raw pixel formats	BayerRG8, BayerRG12, BayerRG12Packed
General purpose inputs/outputs (GPIOs)	
Opto-isolated I/Os	2 inputs, 2 outputs
RS232	1
Operating conditions/dimensions	
Operating temperature	+5 °C to +45 °C ambient (without condensation)
Power requirements (DC)	8 to 30 VDC AUX or IEEE 802.3af PoE
Power consumption	External power: 3.2 W at 12 VDC Power over Ethernet: 3.9 W
Mass	190 g; 200 g (PoE)
Body dimensions (L × W × H in mm)	86.3 × 44 × 29 (including connectors)
Regulations	CE: 2014/30/EU (EMC), 2011/65/EU, including amendment 2015/863/EU (RoHS); FCC Class B; CAN ICES-3 (B)

Quantum efficiency

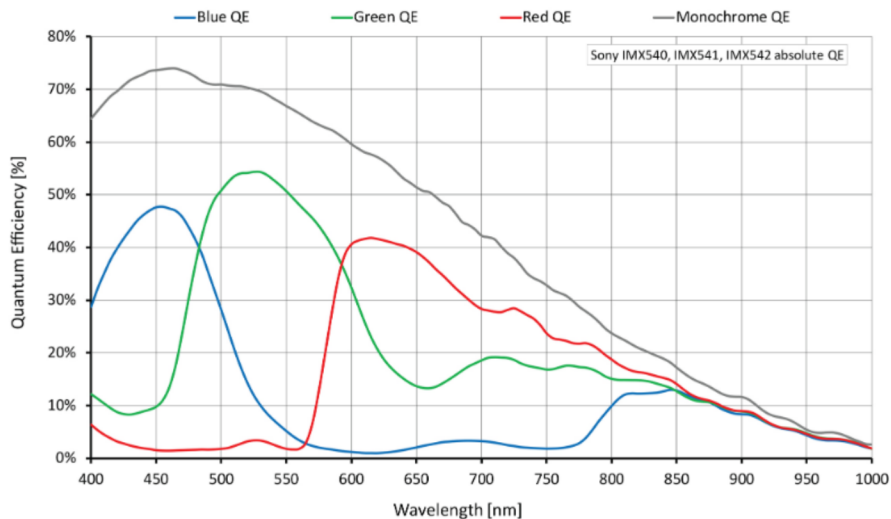

Features

Image optimization features:

- Auto gain (manual gain control: 0 to 40 dB; 0.1 dB increments)



- Auto exposure (exposure time control: 4 μ s to 171.8 s; 1 μ s increments)
- Auto white balance (G-2460C only)
- Binning
- Black level (offset)
- Color correction, hue, saturation (G-2460C only)
- Decimation
- Defect pixel masking (user defined with Defect Mask Loader tool)
- Gamma correction
- Contrast enhancement via look-up table
- Region of interest, separate region for auto features
- Reverse X/Y

Camera control features:

- Auto-iris (video type)
- Event channel
- Image chunk data
- IEEE 1588 Precision Time Protocol
- Storable user sets
- StreamBytesPerSecond (bandwidth control)
- Stream hold
- Sync out modes: Trigger ready, input, exposing, readout, imaging, strobe, GPO
- Temperature monitoring (main board)
- Trigger over Ethernet Action Commands

Technical drawing

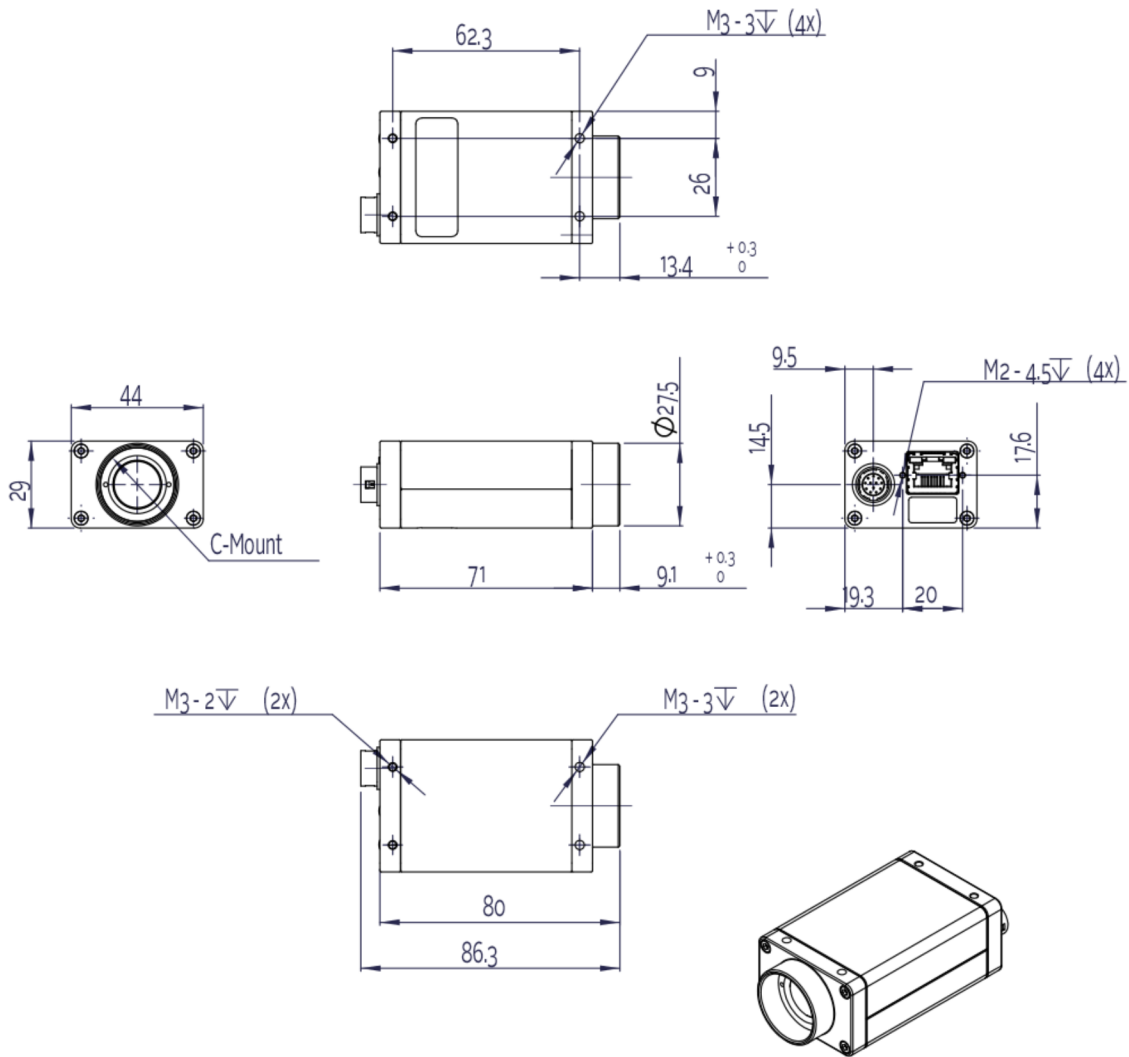



Applications

Manta G-2460 is ideal for a wide range of applications including:

- Machine Vision
- Broadcast analysis requiring Full HD such as sports analytics
- Industrial inspection
- Security and surveillance
- Intelligent traffic solutions (ITS) including traffic monitoring, speed enforcement, and toll collection
- Low light or high sensitivity conditions
- Outdoor applications with dynamic lighting situations