

HPD

Superconducting and Spin Qubit Pre-Screening

Integrated measurement solutions for advanced
quantum development

2X Faster Development Cycles for Quantum Engineers by Pre-Screening at 50 mK

Quantum system engineers working at milli-Kelvin temperatures are faced with the difficulties and inconveniences of long development cycles. The major factors leading to lengthy and costly development cycles include:

- Complicated fabrication process with multiple additive and subtractive steps required to produce a superconducting or spin qubit device
- Time-consuming wire bonding and expensive packaging processes prior to cryogenic test and measurement
- Testing devices at <15 mK requires dilution refrigeration (DR) and long cooldown times exceeding 30 hours
- Qubits that fail final deployment due to poor performance or parameter offsets require warming up the system and loading a new device

"Wire-bonding of high-performance quantum and classical superconducting integrated circuits is a time consuming, intricate, low reliability process that is a common hassle for many cryogenic electronics developers," said Oleg Mukhanov, a developer of quantum computing systems, in which superconducting qubit and single flux quantum (SFQ) chips are combined to achieve high system scalability."

"With FormFactor's HPD probe socket solution, we have been able to eliminate wire-bonding for qubits, SFQ circuits, and multi-chip modules to enable faster device characterization to identify the known-good die for final quantum testing. This has streamlined and improved our device characterization process especially in providing fast feedback to our superconducting foundry fabricating superconducting integrated circuits and multi-chip modules."

- Oleg Mukhanov, CTO of Seeqc

FormFactor and Keysight have collaborated to develop an **integrated measurement solution for Pre-Screening Qubit Devices** that allows quantum system engineers to eliminate wire-bonding and packaging from cryogenic test processes and to provide critical qubit performance parameters at 50 mK to enable streamlined deployment in their existing dilution refrigerators at 20 mK to enhance development cycle times by more than 2X. The joint integrated measurement solution is fully optimized for qubit pre-characterization applications which eliminates the time-consuming process of selecting each individual piece of equipment and integrating it. The system returns initial qubit parameters to accurately pass/reject devices prior to final deployment in a dilution refrigerator. An example qubit pre-characterization routine implemented on the Model 106 integrated solution by a leading superconducting circuit developer, Seeqc, can be found in the final section of this brochure.

The FormFactor **Model 106 integrated measurement solution** utilizes Keysight's **Labber Quantum software** and the Keysight **PXI-based quantum control solution** to provide a turnkey cryogenic system with quick-cooldowns to less than 50 mK in approximately 16 hours. The system is used to rapidly characterize and screen superconducting or spin qubit devices prior to deployment.



Figure 1. Left – Seeqc test engineers working with the Model 106 integrated measurement solution. Right – Internals of the Model 106 system shown equipped with a PDS500 socket configured for accepting bare, singulated die. There are 24 RF connections and 48 shielded twisted pairs (86 DC lines in total) at the device interface.

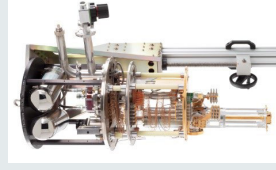

Figure 2. Electronics rack with Keysight PXI embedded controller and PXI modules used in the Model 106 Integrated Measurement Solution. Image courtesy of Seeqc.

Keysight PXI-based Quantum Control System With Labber Control Software

The Model 106 solution is a turnkey experimental platform that utilizes the Keysight PXI-based quantum control system and Labber Quantum software for streamlined measurements and data acquisition. The backbone of the Keysight PXI platform is the M9037A Embedded Controller that has been configured for qubit pre-characterization measurements. The PXI modules have been selected so that a user can switch between time-domain measurements and steady-state measurements (see Table 1 for more detail).

The PXI-chassis is configured with the following modules:

- (2) M3202A Arbitrary Waveform Generators
- M9037A Embedded Controller
- M9615A Source/Measure Unit (SMU)
- M9347A Dual Direct Digital Synthesizer (DDS) for the Local Oscillator (LO)
- M9300A Frequency Reference (REF)
- M3102A Digitizer for Analog-to-Digital Conversion (ADC)
- M9804A Vector Network Analyzer (VNA)

Figure 3 shows an electrical schematic of the Keysight PXI system, configured for prescreening of quantum devices. The diagram also highlights in-line circuit elements that are installed in the FormFactor HPD Model 106 ADR cryostat.

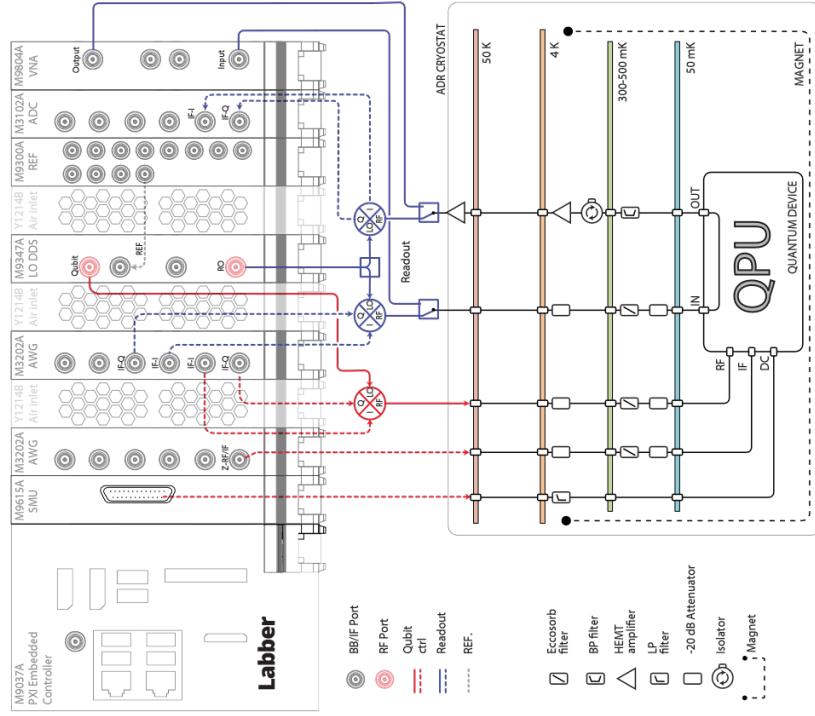

Figure 3. Turn-key experimental platform for electrical measurements on quantum devices based on the Keysight PXI Quantum Control solution with integrated cryostat operational control via the Labber software. Shown here is an example configuration with qubit control and readout that utilizes a combination of a vector network analyzer (VNA), arbitrary waveform generator (AWG), source measure unit (SMU), local oscillator (LO), digitizer, and a frequency reference.

The **Labber Quantum software** provides unified control for all the modules listed above in addition to the newly integrated FormFactor ADR cryostat control. This means that a user may automate the pump-down, cooldown, and qubit characterization measurements from a single platform. Labber includes an Instrument Server, a Measurement Editor, and a Log Browser.

The **Instrument Server** is used to establish communication with each of the PXI modules as well as the Model 106 cryostat control system. Both physical and virtual instruments can be used, allowing users to implement software routines to create waveforms, perform on-the-fly analysis protocols, or any other function that might be required by the user.

The **Multi-qubit pulse generator** is an essential virtual driver in the Labber software that can be used to define the duration, shape, and timing of microwave pulses for qubit control and readout. The graphical user interface provides a straightforward visualization of the pulse design with simple controls to make adjustments.

The **Measurement Editor** allows a user to define all the measurement instructions which includes configuring settings for each of the individual instruments. The Signal Connections feature in Labber then allows the user to define the AWG target channel for the waveform. A series of instructions can be assembled into a step sequence from which the full qubit pre-characterization procedure can be built up.

The **Labber Python API** is a powerful tool that enables users to off-load repetitive measurement sequences and automate the data analysis to extract critical qubit parameters. In a real experimental scenario, the user will need to make a series of measurements that iteratively extract parameters from the qubit to get the final parameter of interest.

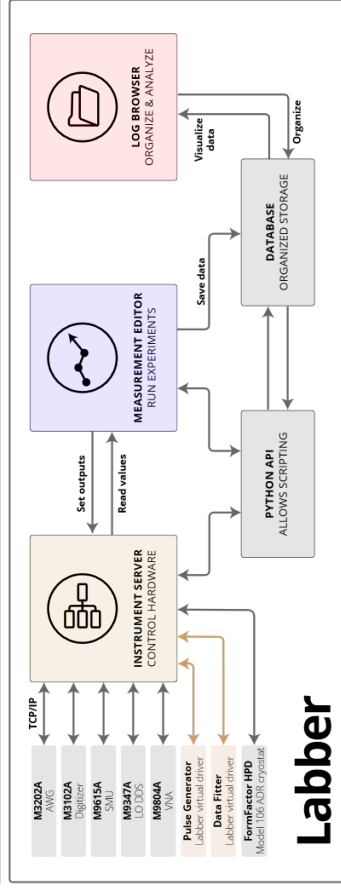

Figure 4. Schematic structure of the Labber modules. See text for description.

FormFactor-HPD Model 106 ADR Cryostat

The Quantum Processing Unit (QPU) that contains the qubits for quantum operations must be installed in a well-controlled environment. The **FormFactor-HPD Model 106 ADR Cryostat** has been tailored to provide an ideal environment for pre-characterization measurements on QPUs.

Superconducting and spin qubits require temperatures below 50 mK to extract parameters such as the resonant frequency and coherence time. The Model 106 utilizes a solid-state two-stage adiabatic demagnetization refrigeration module (ADR) to achieve a **base temperature below 50 mK**. The ADR is backed by a closed-cycle pulse tube cryocooler that provides intermediate temperature intercepts at the nominal temperatures of 50 K and 4 K, with the final temperature intercept at 300 mK connected to the first stage of the ADR.

Quantum processing units based on superconducting and spin qubits typically require **many input and output lines** that can be customized to the specific application requirements or user preferences. The three intermediate temperature intercepts are used to carefully anchor the heat load from each of the input/output lines to ensure the lowest base temperature and longest hold time (Figure 5). The system comes standard with electronics breadboards which can be configured with additional qubit characterization elements such as filters, attenuators, or DC blocks (shown schematically in Figure 2). The coaxial lines use NbTi inner conductor between the 4 K and mK plates for ultra-low heat leak into the final sample environment.

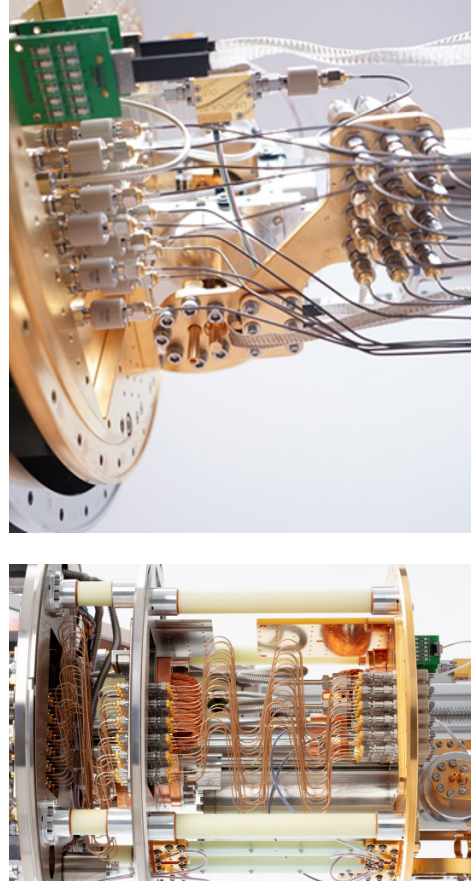

Figure 5. Left image shows the routing of semi-rigid coaxial lines at the intermediate temperature intercepts. Right image shows RF circuit elements (gray cylinders) on the 3 K intercept and DC wiring with filtering (green PCB in top right).

The Keysight PXI-based input/output signal communication and conditioning system is connected to the cryostat through several carefully engineered vacuum-sealed feedthroughs. Figure 4 shows the bulkhead feedthrough plate that contains 24 SMA coaxial connectors having a bandwidth < 18 GHz and 48 shielded twisted pairs that are terminated with micro-D connectors on the atmosphere side.

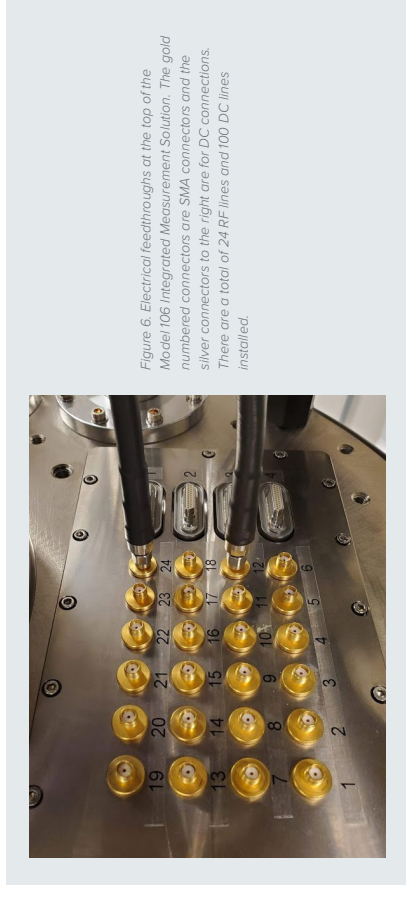

Figure 6. Electrical feedthroughs at the top of the Model 106 Integrated Measurement Solution. The gold numbered connectors are SMA connectors and the silver connectors to the right are for DC connections. There are a total of 24 RF lines and 100 DC lines installed.

Closed-cycle operation ensures that the user does not need to be concerned with the hassle and expense of using liquid helium. Unlike dilution refrigerators (DRs) the ADR uses a solid-state cooling method and does not require 3-He which is a very expensive component and necessitates the use of a complicated gas handling system.

The system **rapidly cools** from room temperature to base temperature in under 16 hours with the rapid cooldown control option. This ensures that the user can rapidly cycle samples and obtain important qubit characteristics prior to deploying the QPU in a host DR. The two-stage ADR has a hold time of more than 35 hours which provides the user with ample time to perform the full suite of qubit pre-characterization measurements.

Integrated magnetic shielding provides quiescent fields below 100 nT to ensure superconducting qubits are not disturbed by stray magnetic field. Alternatively, spin qubit applications can be augmented with a permanent or superconducting magnet having max fields exceeding 5 T. The vacuum jackets are equipped with integrated RF shielding elements to ensure a low-noise environment.

PQ500 Probe Socket - Simplifying the DUT Interface

Interfacing to the Quantum Processing Unit has been simplified with the PQ500 probe socket. The PQ500 makes use of a custom flexible circuit designed to match the pad layout of the device under test (DUT) and can be configured with additional IR and DC lines. The flex circuit forms the precise and repeatable electrical contact between the input/output system and the DUT using flip-chip style bonds. This allows a user to load an unpackaged singulated die with dimensions up to 10 x 10 mm² taken directly from a wafer for immediate testing at milli-Kelvin temperatures. The PQ500 probe socket therefore eliminates the need to wire bond and package the device prior to test and measurement. The mounting system does not require the use of any greases, epoxies or other possible contaminants.

An embedded temperature sensor provides accurate device temperature readout. An adjustable spring clamp is used to provide optimal heatsinking for the device and ensure milli-Kelvin performance. This novel socket design allows a user to load a sample and begin the cooldown procedure in less than 20 minutes.

The non-magnetic construction of the PQ500 socket ensures compatibility with low and high-magnetic field applications. This ensures both superconducting and spin qubit devices can take advantage of the PQ500 probe socket.

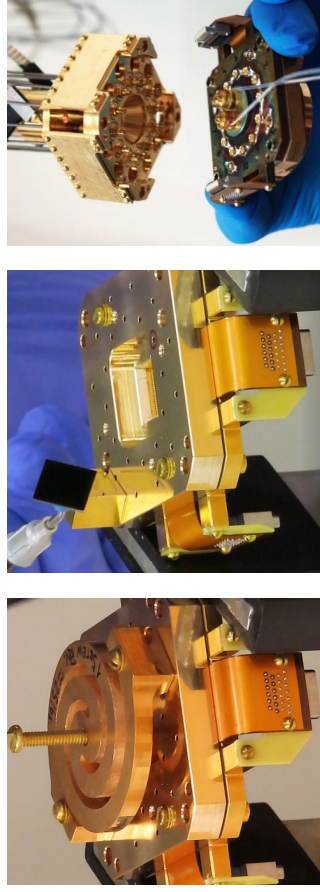

Figure 7. FormFactor PQ500 probe socket for rapid device loading. Left – Fully assembled sample nest showing the spring clamp that provides contact pressure for good thermal performance. Middle – example 10 x 10 mm² DUT being loaded into the sample nest. Right – Fully assembled sample nest being inserted into the upper half of the socket that is anchored to the ADR stage. The mating SMPM connectors and sample thermomometer can be seen.

Rapid Development Cycles with ADR Pre-Characterization

Quantum developers looking to improve their development cycles must carefully consider the inefficiencies in how devices are tested and measured prior to deployment. If a developer relies solely on milli-Kelvin testing with a dilution refrigerator, they are putting themselves at risk for a significantly longer development cycle.

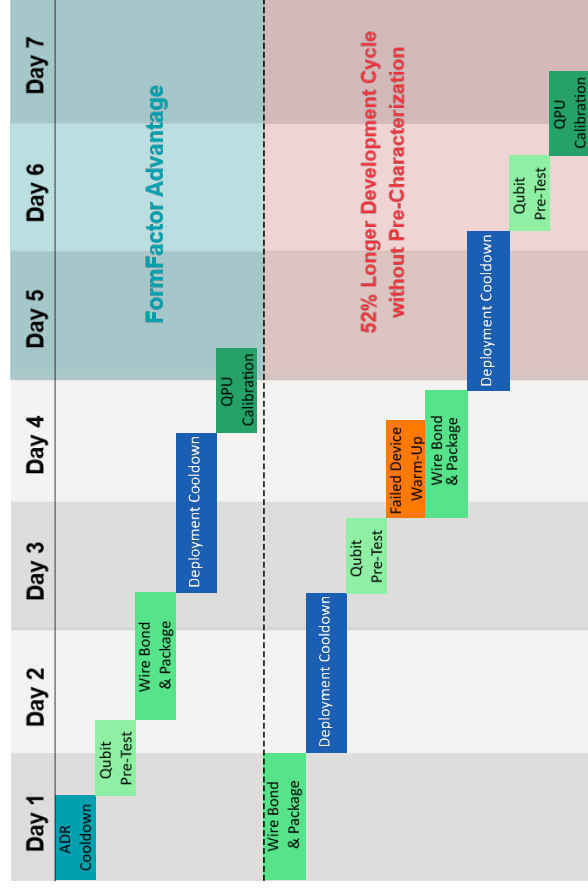

Figure 8. Timeline showing a typical development cycle with (top) and without (bottom) using a Model 106 ADR Cryostat for pre-characterization of quantum devices. Boxes are scaled to the hours typical of each process listed.

Compared the optimal Model 106 ADR pre-characterization setup, a DR only characterization process increases the length of the development cycle by 52%. Multiple failed cooldowns put the developer at a significant disadvantage using DR characterization.

Seeqc: Staying Ahead of the Competition with Short Development Cycles

Seeqc is developing the first digital quantum computing platform for global businesses that leverages both classical and quantum technology through a unique superconducting chip scale architecture. Seeqc has been able to speed up their development cycle more than 2X by pre-characterizing their superconducting devices with the Model 106 Integrated Measurement Solution. The pre-characterization measurements allow Seeqc to ensure only the best performing devices are deployed in the DR. The pre-characterization measurements on the qubits also allow Seeqc to forward this information to the deployment device which has reduced the time spent on setup and calibration of the qubits in the deployment cryostat.

Table 1 below highlights Seeqc's key measurement protocols and observables for each of the pre-characterization steps that is performed with the Model 106 Integrated Measurement Solution. Once the pre-screening protocol is complete, the key quality and operating parameters of each qubit in the quantum processor are known. The operator can then make an informed decision about packaging and deploying the device. The same information can also be used for further improvements of the qubit fabrication process.

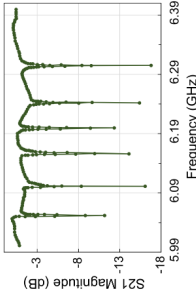
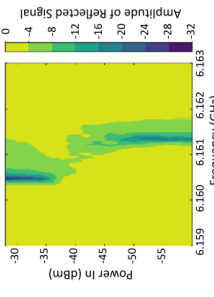
The Observable	Measurement Protocol
<p>Cavity resonance frequency</p> 	<p>S21 scan with Keysight M9804A VNA. All cavities are connected to a single feed line, enabling multiplexed qubit readout. A dip appears where the frequency is on resonance with one of the readout cavities.</p>
<p>Cavity dispersive shift</p> 	<p>Repeat S21 scan above as a function of increased power, producing a 2D map of S21 versus probe power and frequency around each readout resonator.</p>
<p>Defines a frequency range for each of the cavities used for qubit readout. Seeqc implements a design frequency of ~6 GHz. Resonant frequencies and quality factors of the readout resonators can be extracted.</p> <p>One signature that a working qubit is coupled to the readout resonator is that the frequency of the resonator shifts (typically ~1 MHz) as the resonator probe power is increased. This shift can be used to get a rough estimate of the qubit transition frequency between its two states $0\rangle$ and $1\rangle$, given that the qubit-resonator coupling is known.</p>	<p>Repeat S21 scan above as a function of increased power, producing a 2D map of S21 versus probe power and frequency around each readout resonator.</p>

The Observable	Measurement Protocol
<p>Qubit transition frequency</p> 	<p>Determine the energy transitions of the qubit device. Estimate the qubit anharmonicity.</p>
<p>Rabi oscillations</p> 	<p>Verify that spectroscopy peaks correspond to qubit transitions. First step of calibrating qubit gates and extract coupling rates between on-chip qubit drive antennas and the qubit island. Defines a π-pulse for the qubit.</p>
<p>Qubit relaxation time (T_1)</p> 	<p>Defines the T_1 relaxation time, or the decay from first excited state to ground state. This is the time limit for a quantum computation algorithm for the qubit. This will be a lower bound at 50 mK since T_1 improves at lower temperatures in the final DR deployment system.</p>

Table 1. A list in sequential order of the pre-characterization measurements performed on a superconducting qubit device to evaluate device quality and operating parameters. Graph insets show representative data from superconducting qubit devices. RO – readout tone, QD – qubit drive tone, AWG – arbitrary waveform generator, VNA – vector network analyzer, LO – local oscillator, DDS – direct digital synthesizer.

To learn more about how FormFactor and Keysight can enable your quantum development program and customize a solution for your needs, visit [FormFactor.com](https://www.formfactor.com) or contact your local agent today!

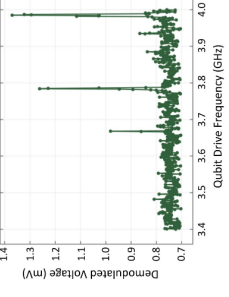
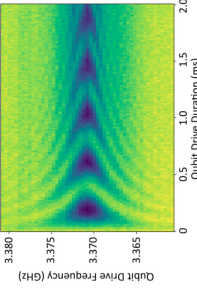
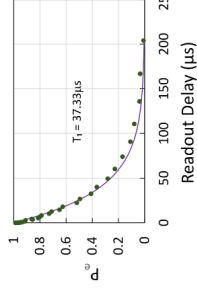

Website: www.keysight.com/find/quantum

Twitter: @KeysightQ

©Copyright 2021, FormFactor, Inc. All rights reserved. FormFactor and the FormFactor logo are trademarks of FormFactor, Inc. All other trademarks are the property of their respective owners.

All information is subject to change without notice.

BR-FF-KS-SEEQC-1021

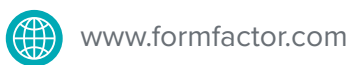

www.formfactor.com



[@formfactor](https://www.linkedin.com/company/formfactor)



[FormFactor Inc.](https://www.youtube.com/FormFactor)