

Cascade

Advanced mm-Wave Load-Pull Measurements

mm-Wave Harmonic Load-Pull Measurements to 110 GHz
with Option for Over-Temperature Capability

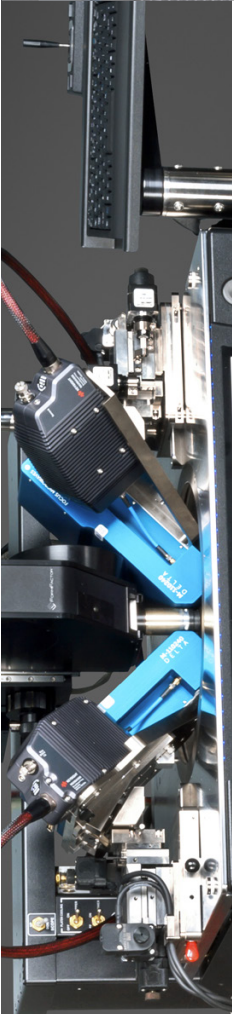

Advanced mm-Wave Load-Pull Measurements Best-in-Class Tuning Range Performance with Minimized Insertion Loss

The ramp-up of 5G mm-Wave technologies comes with substantial enhancements in connectivity, revolutionizing smart cities, the internet of things, vehicle to everything (V2X), and more.

One of the fundamental requirements of such 5G devices is to maximize their performance by optimizing power and/or efficiency of the contained amplifiers and transistors. This is done by measuring

the performance characteristics of the device under test at different impedances that are systematically changed using load-pull tuners.

FormFactor has partnered up with Focus Microwaves and Keysight Technologies to deliver a fully integrated solution for accurate on-wafer mm-Wave load-pull measurements.

The solution delivers best-in-class tuning range performance with minimized insertion loss, and enables highly accurate, very phase-stable and reliable contact. Small pad probing is enabled by high-resolution microscope compatibility, and the optional RF TopHat provides an EMI-shielded, dark and frost-free environment.

"FormFactor's load-pull integration delivers best-in-class tuning range performance with minimized insertion loss."

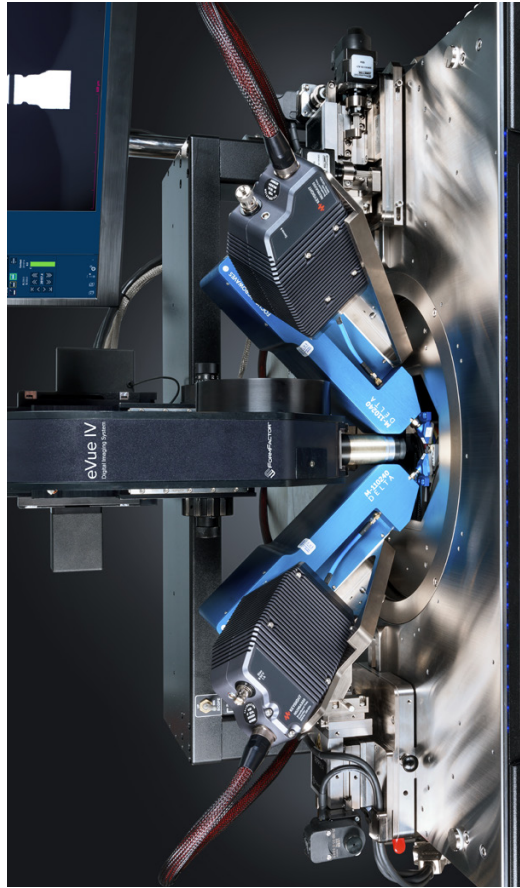

FormFactor's SUMMIT200 Probe Station with fully-integrated 110 GHz DELTA tuners for advanced mm-Wave load-pull measurements. The solution is also available for the MPS150, PM8, Summit 12000/f1000, CM300vi and Elite.



Features



Best-in-Class Tuning Range
Direct connect probes
maximize **Gamma**



Small Pad Probing
High power microscope
compatibility



Measurements Over Temperature
Optional **RF TopHat**:
EMI-shielded, dark and frost-free
-60 to 125°C



Calibration Accuracy
Easy to perform **coaxial** and
on-wafer calibrations

Powerful Partnerships, Advanced Solutions

- / Powerful, integrated test and measurement solutions with best-of-breed partners
- / Eliminates the time and risk involved in sourcing incompatible products from multiple vendors
- / Provides confidence in measurement by applying combined know-how and expertise
- / Partners share a commitment to customer success and seek to understand and solve future customer challenges
- / Single point of contact to coordinate the optimal customer solution, managing all aspects of configuration, installation, service and performance

MeasureOne™
Your Integration Connection



MeasureOne™ is a unique commitment between FormFactor and a select group of partners to deliver optimized solutions to address customers' applications. FormFactor and its MeasureOne partners work together to configure and install solutions with validated performance and post-installation service and support.



Low-Loss Measurement Channel Maximized Tuning Range

What Affects the Tuning Range?

To find the point of optimum performance of a device, it is essential to maximize the tuning range over the Smith chart. An increased tuning range provides more characterization data and enables higher certainty in defining the point of maximum performance.

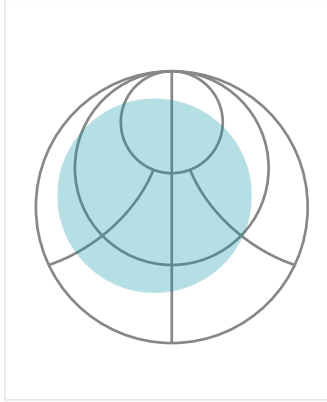

Figure 1: Draft of a Smith chart. The blue area marks the available tuning range that can change with the measurement setup.

The tuning range is affected by the measurement path which traditionally included a big tuner, a coupler, a cable and a probe (Figure 2). These components will always increase insertion loss which reduces and/or shifts the tuning range to a certain area of the Smith chart, especially at higher frequencies. The use of flexible cables can additionally cause impedance shifts, which leads to inaccurate tuner calibrations.

Consequently, keeping the electrical measurement path as short as possible and highly stable is preferred to maximize characterization accuracy.

New Approach with Reduced Measurement Path

The new DELTA tuners from Focus Microwaves are specifically designed for on-wafer integration, which allows them to be located as close to the wafer as physically possible, without the need for a coupler and a cable. FormFactor's Infinity probes can be directly connected to the test port of the tuner, which minimizes insertion loss and maximizes gamma, allowing a very large cover of tunable impedances over the Smith chart.

Another key benefit of the DELTA tuner setups is the shortened electrical delay resulting in reduced impedance skew for modulated signals. Legacy high frequency setups suffer from significant impedance skews due to the long electrical delay caused by the low loss cable inserted between the tuner and device under test. The DELTA tuner drastically reduces this skew making wideband modulated load pull possible with passive tuners.

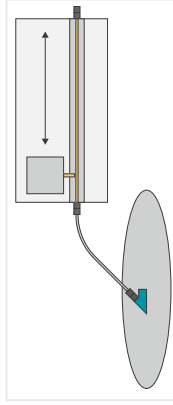

Figure 2: Traditional tuner with cable.

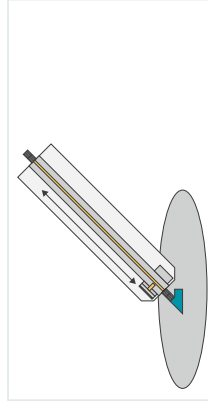
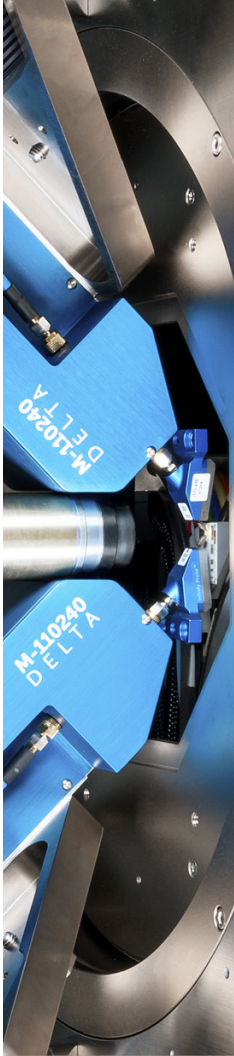

Figure 3: Shortened measurement path: FormFactor's Infinity probe is directly connected to the DELTA tuner from Focus Microwaves.



Performance Results – Tuning Range

Figures 4, 5 and 6 show the optimized tuning range at three different frequencies that are typically used for test of 5G devices. The setup uses the DELTA tuners from Focus Microwaves with FormFactor's Infinity Probes, fully integrated into a SUMMIT200 probe station and with the N5291A frequency extenders from Keysight.

Independent of the setup, insertion loss gets higher with frequency which leads to a slightly shrinking tuning range.

The below results show an excellent tuning range from $\Gamma_{max} = 0.84$ at 28 GHz to $\Gamma_{max} = 0.7$ at 96 GHz.

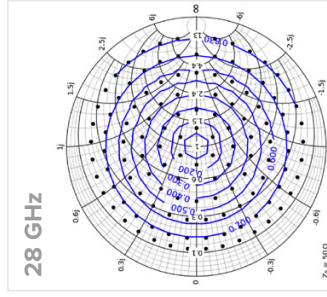

Figure 4: Tuning range at 28 GHz:
 $\Gamma_{max} = 0.84$, $\Gamma_{max_360deg} = 0.79$

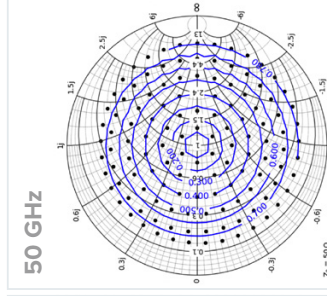

Figure 5: Tuning range at 50 GHz:
 $\Gamma_{max} = 0.79$, $\Gamma_{max_360deg} = 0.74$

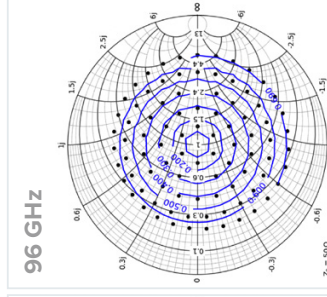

Figure 6: Tuning range at 96 GHz:
 $\Gamma_{max} = 0.7$, $\Gamma_{max_360deg} = 0.63$

The above charts show the tuning range of a single probe tuner. A useful application of multiple probe tuners is single frequency high Gamma tuning.

If one slug is used as a prematching section, the second slug can tune around it and reach very high reflection factors in a selected area of the Smith chart. Reflection factors of 0.85 or greater can be met (VSWR > 10:1 at DUT reference).

If that is still not enough, these tuners can be used in hybrid mode with an active injection signal to bridge the gap and increase the tuning range even more.

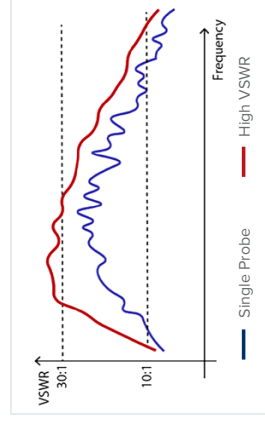

Figure 7 illustrates the frequency responses of a single wideband probe and a high VSWR dual probe which has increased tuning range.



Accurate Probing of Small Pads High Resolution with Perfect Fit

Smaller pad geometries come with several advantages like saving valuable wafer space and reduced pad parasitics. Many devices today have pads as small as 30 µm. To properly see those pads and probe them accurately with RF probes, a high-resolution microscope system is essential.

FormFactor's load-pull setup integrates a high-resolution microscope – either the eVue or the SlimVue – enabling highest visibility of contact pads as small as 30 µm with micron level accuracy.

The dedicated high magnification, high resolving power objective perfectly fits between the tuners so that the probes can come together as close as needed without hitting the microscope, even if there are only 100 or 200 µm separation.

This makes it possible to probe even very small transistors with minimal probe-to-probe distance and calibrate on standards with small calibration structures. Standard LRRM calibration substrates can be used and there is no need of special calibration standards.

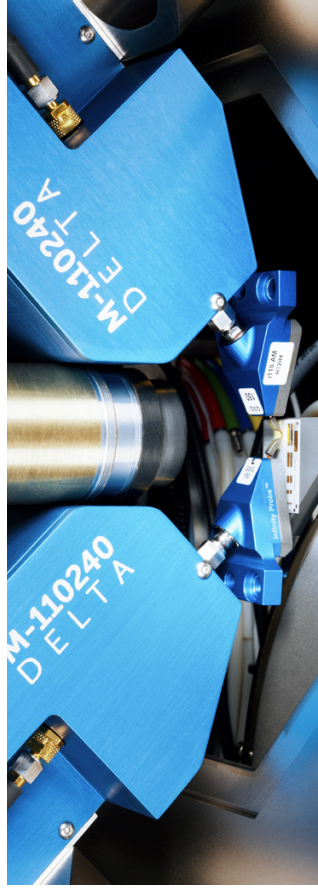

Load-pull measurement setup: FormFactor's infinity probes are connected directly to the tuners. This minimizes insertion loss and maximizes Gamma. The setup integrates a high power microscope objective, enabling easy visibility of contact pads as small as 30 µm with micron level accuracy. FormFactor's patented eVue Crash Detection protects your valuable equipment.

Safety Features

eVue Crash Protection

FormFactor's patent-pending eVue Crash Detection protects your valuable equipment from expensive damage, even when probes are in contact. When accidentally hitting the tuner or probes, the microscope will instantly stop all movements and retract the objective.



Velox Software Fence

Additional software fences in the Velox probe station control software avoid a collision between the tuners and the microscope objective by defining a limit of how much the microscope can be moved.



Coaxial Calibration with Highest Phase Stability

With any tuner system, on-wafer calibration down to the probe tips is needed. Additionally, the end of the cable of the Keysight N5291 frequency extender needs to be calibrated to the input of the tuner. This coaxial calibration characterizes the insertion loss of the tuner in all different locations around the Smith chart.

FormFactor's millimeter-wave load-pull solution uses a short 10 cm cable from the Keysight N5291 frequency extender to the tuner input. This

maximizes the available power. The cable is semi-rigid to prevent phase change error due to cable movement.

To connect a coax standard to the end of the cable, the Keysight N5291A frequency extender can easily unclamp and slide back via quick release mechanism.

For thru calibrations the extenders can be lifted off and brought together to add a thru standard between the two cables.



To connect a coax standard to the end of the cable, the Keysight N5291 frequency extender can easily unclamp and slide back via quick release mechanism. The cable is semi-rigid and provides highest phase stability.



Full Thermal Range Exclusive RF TopHat with Probe Window

With 5G devices powering the vehicle to everything (V2X) market there is a need for EMI and light-tight testing at a wide temperature range, including tests down to -40°C without a build-up of frost and condensation.

With FormFactor's patented RF TopHat®, the solution has full thermal capability from -60°C to +125°C. The RF TopHat was designed to minimize cable lengths, prevent stiction which impacts motorized positioner accuracy, and maintain a dark, shielded and frost-free measurement environment.



The exclusive I.T.O. coated TopHat window allows easy setup and tracking of probes without having to open the MicroChamber. The window is always shielded, always frost-free and includes a cover for dark measurements. The patented FlexShield interface enables resistance-free and highly accurate probe positioning.

The setup can be converted between TopHat and non-TopHat to meet different test requirements.

I.T.O. Coated Window

- Easy setup of probes
- EMI-shielded and frost-free
- Cover for dark measurements



FlexShield

- Resistance-free and highly accurate probe positioning
- Dark, shielded and frost-free



RF TopHat with I.T.O. coated window and patented FlexShield Interface.

-60°C

+125°C

* Available for CM300x4, SUMMIT200, Summit 12000 and Elite 300.



Performance Results with RF TopHat – Tuning Range

A straight, very rigid and short cable that connects the tuner with the probe inside the TopHat provides very high phase stability. Figures 8 and 9 show that the impact of this cable on the tuning range is minimal.

The setup uses the DELTA Tuners from Focus Microwaves with FormFactor's Infinity Probes, fully integrated into a SUMMIT200 probe station with MicroChamber and RF TopHat, and with the N5291A frequency extenders from Keysight.

In this example measurement at 28 GHz, Γ_{max} ranges from 0.84 without TopHat, to 0.74 with TopHat. The compromise for a fully shielded environment is only less than 0.1.

28 GHz

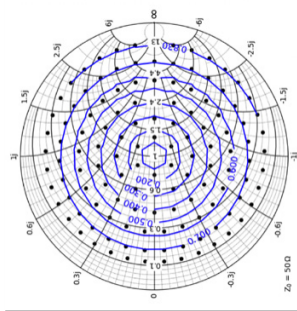

Figure 8: Tuning range at 28 GHz without RF TopHat.
 $\Gamma_{max} = 0.84$, $\Gamma_{mic_280log} = 0.79$

28 GHz

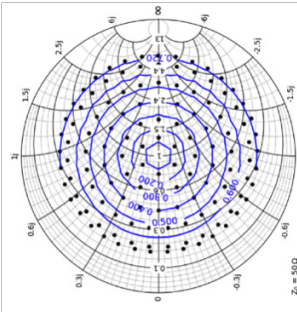

Figure 9: Tuning range at 28 GHz with RF TopHat.
 $\Gamma_{max} = 0.74$, $\Gamma_{mic_280log} = 0.7$

Unique Ergonomic Concept Completely Modular Solution for Easy Swapping Between Bands

FormFactor's engineers constantly strive for maximum ergonomomy and ease of use. Consequently, our RF positioners are completely modular. You can simply choose between a manual or programmable

positioner body and add a specific arm. The arms are equipped with a dovetail that makes it easy, safe and fast to change between different measurement applications.

Positioner Body

Manual

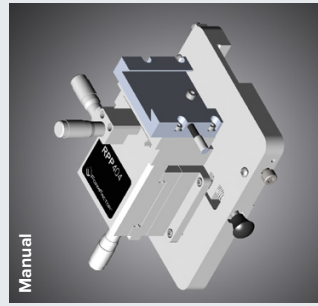

Programmable

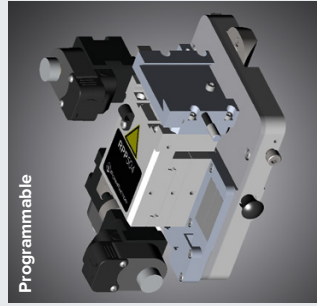

Positioner Arm

< 67 GHz S-Parameter

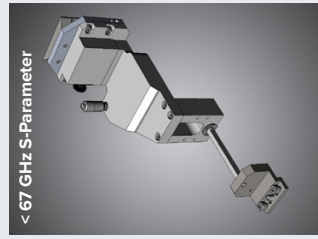

120 GHz Keysight N5291

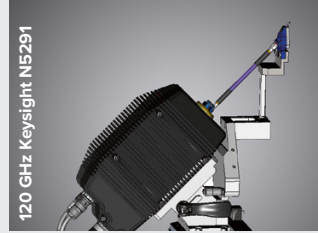

50-330 GHz VDI Extenders

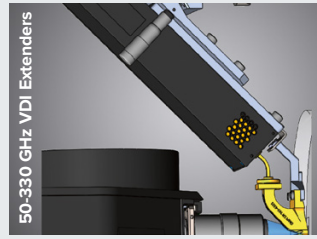

67 or 110/120 GHz Focus DELTA Tuners

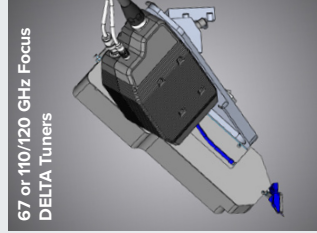

Manual and Programmable Positioners Perfected Probe Positioning with Highest Accuracy and Repeatability

Our RPP404 and RPP504 positioners have been developed specifically for high-performance RF, mm-Wave and terahertz measurements, to give the highest positioning resolution for the most accurate and repeatable probe positioning and measurement

performance. With 0.3 μm resolution even the smallest errors can be recognized and corrected. Multiple positioners can be located not only in the east and west, but also the north and south locations.

RPP404 - Manual Positioner

Feature resolution	<1 μm
Travel range (X/Y/Z)	12 mm / 12 mm / 12 mm
Mounting	Bolt down
Footprint (WxD)	124 mm x 149,5 mm

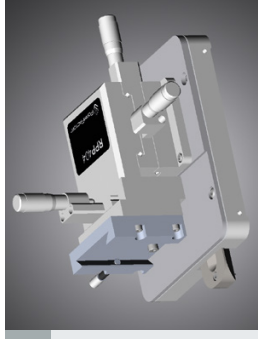

Digital Micrometer Upgrade Kit for RPP404

Separate your RF probes a precise known amount. Particularly useful when performing TRL calibrations which require different lengths of line



RPP504 - Programmable Positioner

Feature resolution	<1 μm
Travel range (X/Y/Z)	12 mm / 12 mm / 12 mm
Minimum step size	0.3 μm / 0.1 μm resolution
Mounting	Bolt down
Footprint (WxD)	124 mm x 149,5 mm

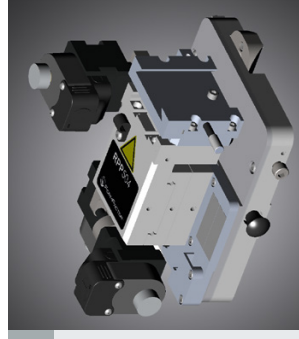

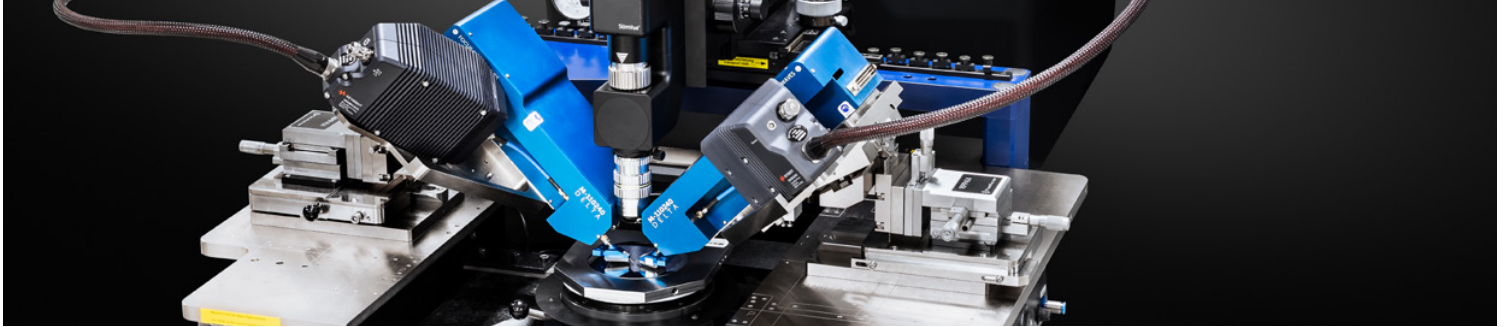

Industry-Leading High-Performance Probes

FormFactor's Infinity Probe is unique in its architecture that delivers industry leading performance. It combines extremely low contact resistance on aluminum pads with unsurpassed RF measurement accuracy to provide highly reliable, repeatable measurements. The Infinity Probe reaches this performance level through the combination of FormFactor's proprietary thin-film technology and coaxial probe technology.



- / Superior field confinement reduces unwanted couplings to nearby devices and transmission modes
- / Lithographic thin-film construction
- / Non-oxidizing nickel alloy tips
- / Probe pitch as narrow as 50 μm
- / Typical lifetime > 250,000 touchdowns on Al pads
- / Typical contact resistance: < 0.05 Ω on Al, < 0.02 Ω on Au

Compatibility

The solution is available for the MPS150, PM8, Summit 12000/11000, SUMMIT200, CM300xi and Elite. 67 GHz and 110/120 GHz versions are available. For 110 GHz measurements, the N5291A Network Analyzer with frequency extenders from Keysight is needed. Only compatible with Infinity 'Angled' probes from FormFactor.

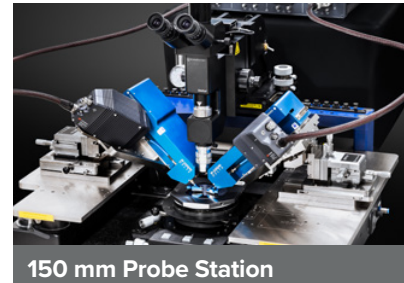
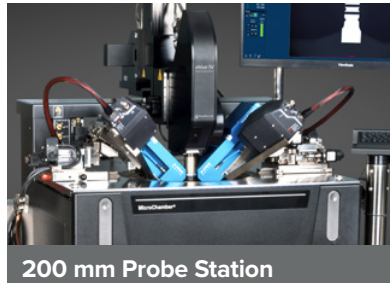
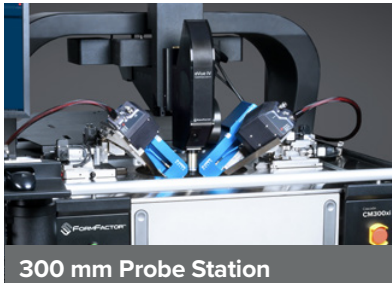

©Copyright 2021, FormFactor, Inc. All rights reserved. FormFactor and the FormFactor logo are trademarks of FormFactor, Inc. All other trademarks are the property of their respective owners.

All information is subject to change without notice.

BR-LOADPULL-0121



www.formfactor.com



@formfactor



FormFactor Inc.