

Cascade

Advanced mm-Wave and Terahertz Measurements

Over-temperature Capability with Lowest Insertion Loss and Highest Calibration Stability

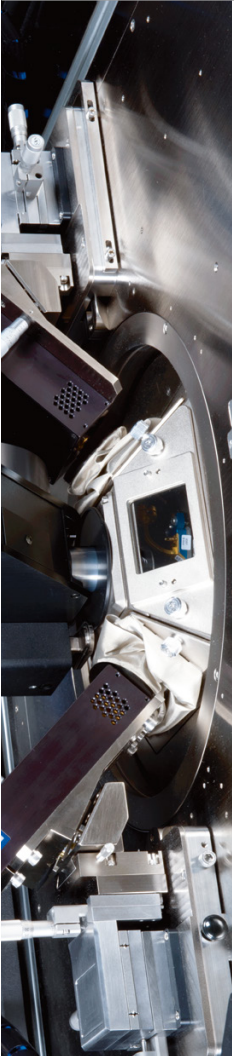

Advanced Over-temperature mm-Wave and Terahertz Measurements

FormFactor's unique solution for over-temperature mm-Wave and terahertz measurements incorporates a new, exclusively developed approach to overcome the challenges in precise waveguide probing.

The result is highest accuracy and reliable data over a full thermal range from -60°C to +125°C.

Optionally enhanced with FormFactor's revolutionary Autonomous RF Measurement Assistant*, the system enables true hands-free calibrations and measurements, reducing cost of test and accelerating time to market.

The solution is available for all manual, semi-automatic and fully-automatic probe systems from FormFactor.

Lowest possible insertion loss	Highest raw directivity and dynamic range	Manual or programmable positioners
Minimized drift over temperature and time	Full thermal capability with RF TopHat	Easy, and safe swapping between bands

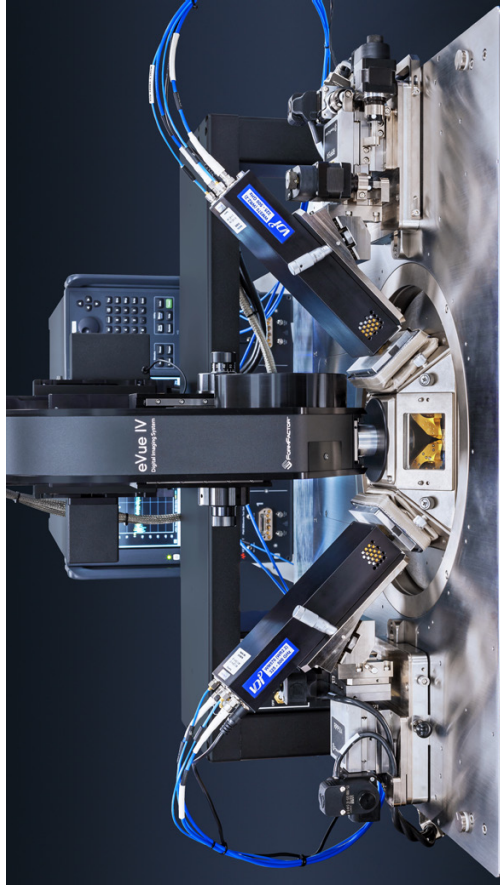

mm-Wave probing on a SUMMIT200. The solution is also available for all other probe systems from FormFactor.



Fully Integrated Measurement Solution

FormFactor takes a holistic view to develop successful approaches to wafer-level testing of mm-Wave and terahertz devices. We have forged partnerships with other industry-leading suppliers of test technology to leverage each contributor's individual strengths. FormFactor applies its

considerable expertise to engineer integration and automation tasks. This creates a robust, supportable solution to get you started making optimized mm-Wave and terahertz measurements without further development. Our solutions help reduce costs, time, and ultimately get your products to market – faster.

MeasureOne™ is a unique commitment between FormFactor and a select group of partners to deliver optimized solutions to address customers' applications. FormFactor and its MeasureOne partners work together to configure and install solutions with validated performance and post-installation service and support.

- / Powerful, integrated test and measurement solutions with best-of-breed partners
- / Eliminates the time and risk involved in sourcing incompatible products from multiple vendors
- / Provides confidence in measurement by applying combined know-how and expertise
- / Partners share a commitment to customer success and seek to understand and solve future customer challenges
- / Single point of contact to coordinate the optimal customer solution, managing all aspects of configuration, installation, service and performance

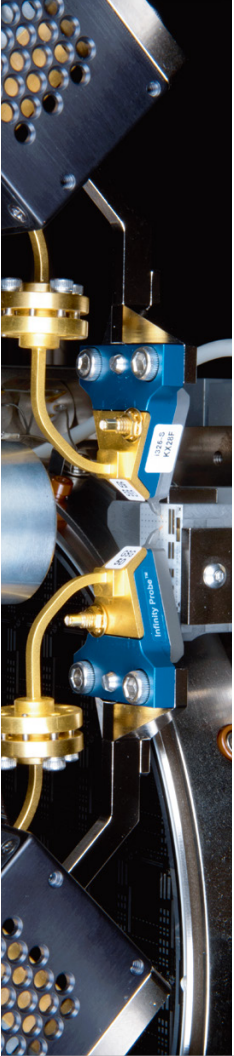

Highest Data Accuracy

Lowest Possible Insertion Loss

By bringing the frequency extender as close to the probe as possible, the new solution drastically shortens the path to the device. This considerably reduces the insertion loss which leads to a higher raw directivity and dynamic range at the probe tip, resulting in highly accurate calibrations.

Extremely Stable Calibrations

The consequent downsizing of the measurement path leads to a minimized thermal expansion as well as improved directivity. The combination of these reduces the drift associated with temperature changes to a minimum and allows calibrations to last longer before the need of re-calibration.

FormFactor's Advanced mm-Wave and Terahertz Solution

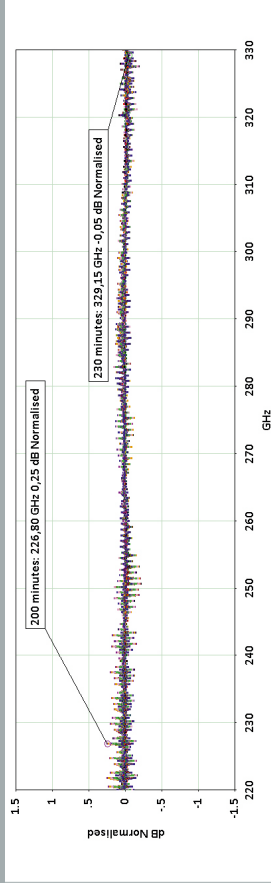

No Attenuator Part 2 - Drift over 780 minutes with multiple traces. Measurements taken every five minutes and normalized to the first one.

Conventional Waveguide Probe Setup

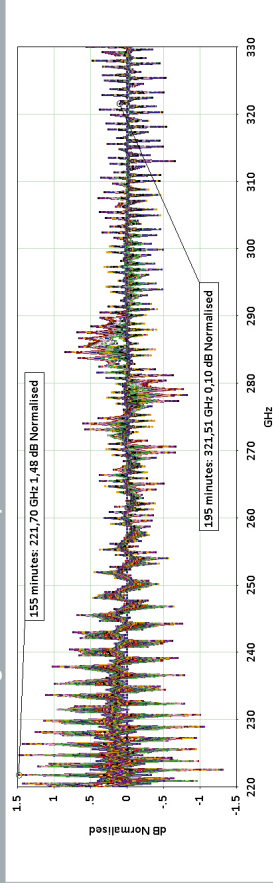

Attenuator Head Part 1 - Drift over 780 minutes with multiple traces. Measurements taken every five minutes and normalized to the first one.

Drift Over Temperature

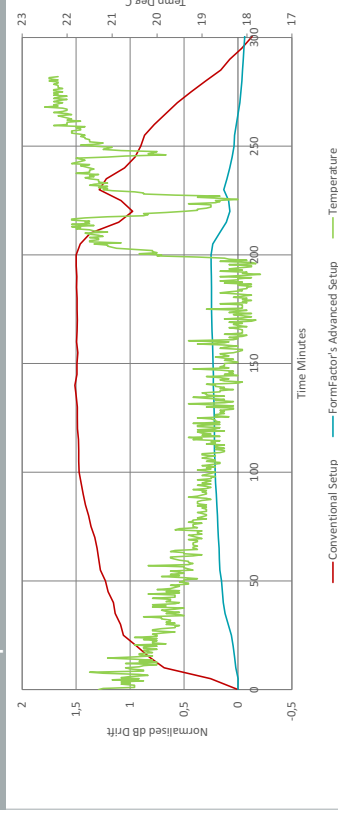

Drift over Temperature - FormFactor's Advanced mm-Wave and Terahertz Solution vs. Conventional Waveguide Setup. Normalized maximum dB drift as a function of time with the current temperature on the secondary Y-axis.

Multiple Measurements Using FormFactor's Autonomous RF Measurement Assistant

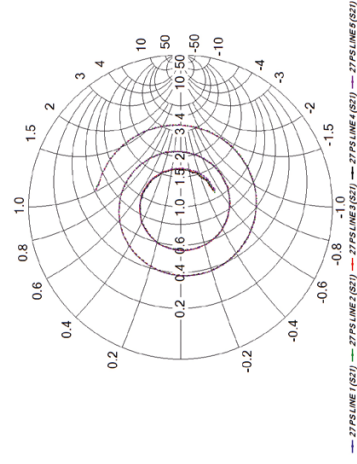

Five S-parameter WR3 measurements from a transmission line electrically 27 ps long. For each calibration, the probes were adjusted automatically using optical pattern recognition and then a new MLTRL calibration was carried out each time. All movements of probes are handled automatically by the system.



Full Thermal Range Exclusive RF TopHat with Probe Window

Exclusive TopHat

Dark, shielded and frost-free	Shortest cable length	Minimized system drift
Unique window for easy set up	Improved dynamic range	Advanced accuracy



With FormFactor's unique RF TopHat*, the solution has full thermal capability from -60°C to +125°C. The RF TopHat was designed to minimise cable lengths, prevent stiction which impacts motorised positioner

accuracy, and maintains a dark, shielded and frost-free measurement environment.

The exclusive TopHat Window allows easy set up of probes without having to open the MicroChamber.

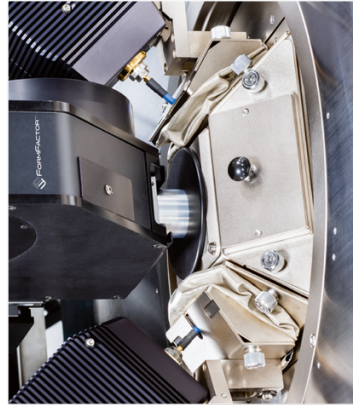
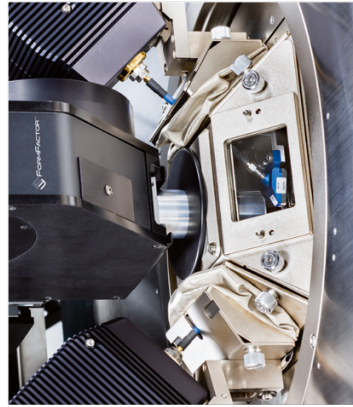

Autonomous RF Measurement Assistant* Faster Time to Market with Increased Accuracy



FormFactor's advanced mm-Wave and terahertz measurement solution can be enhanced with the revolutionary Autonomous RF Measurement Assistant*, which enables fully autonomous, hands-free RF calibrations and measurements over multiple temperatures.

Featuring the unique Contact Intelligence™ Technology, it significantly reduces cost of test and accelerates time to market with increased accuracy and reduced design cycles.

Faster Time to Market

- More modelling data with increased accuracy and reduced uncertainty

Fewer Design Cycles

Reduced Cost of Test

- More tool utilisation with unattended test
- Minimized training costs

Lower Cost of Test

Increased Data Accuracy

- True autonomous calibration monitoring and re-calibration

More Accuracy

* Available for CM300xi, SUMMIT200, Summit 12000 and Elite 300.

* Available for CM300xi, SUMMIT200, Summit 12000 and Elite 300.



Unique Ergonomic Concept Completely Modular Solution for Easy Swapping Between Bands

FormFactor's engineers constantly strive for maximum ergonomics and ease of use. Consequently, our RF positioners are completely modular. You can simply choose between a manual or programmable

positioner body and add a specific arm. The arms are equipped with a dove tail that makes it easy, safe and fast to change between different measurement applications.

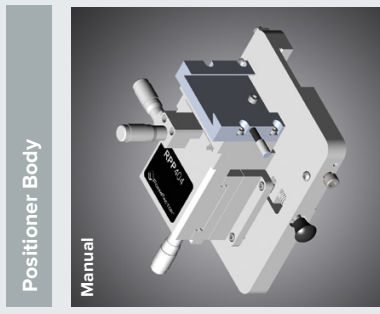

Positioner Body

Manual

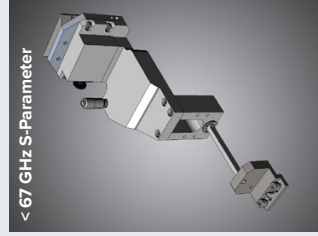

Positioner Arm

< 67 GHz S-Parameter

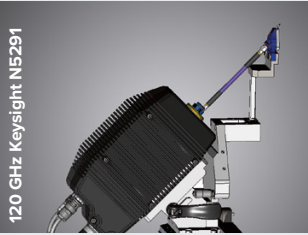

120 GHz Keysight N5291

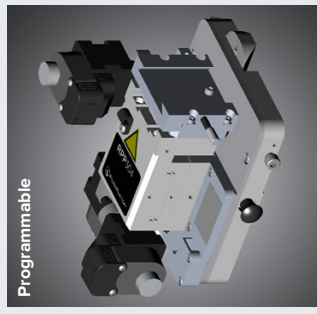

Programmable

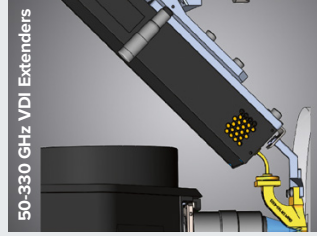

50-330 GHz VDI Extenders

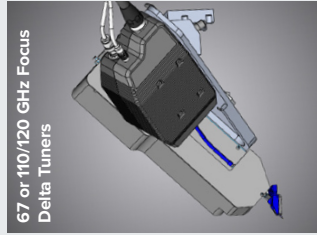

67 or 110/120 GHz Focus Delta Tuners



Manual and Programmable Positioners Perfected Probe Positioning with Highest Accuracy and Repeatability

Our RPP404 and RPP504 positioners have been developed specifically for high-performance RF, mm-Wave and terahertz measurements, to give the highest positioning resolution for the most accurate and repeatable probe positioning and measurement

performance. With 0.3 μm resolution even the smallest errors can be recognized and corrected. Multiple positioners can be located not only in the east and west, but also the north and south locations.

RPP404 - Manual Positioner

Feature resolution	<1 μm
Travel range (X/Y/Z)	12 mm / 12 mm / 12 mm
Mounting	Bolt down
Footprint (WxD)	124 mm x 149,5 mm

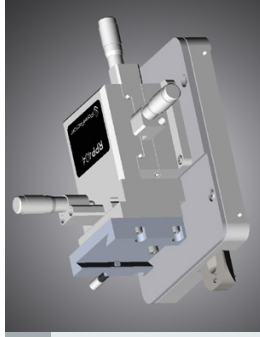

Digital Micrometer Upgrade Kit for RPP404

Separate your RF probes a precise known amount. Particularly useful when performing TRL calibrations which require different lengths of line



RPP504 - Programmable Positioner

Feature resolution	<1 μm
Travel range (X/Y/Z)	12 mm / 12 mm / 12 mm
Minimum step size	0.3 μm / 0.1 μm resolution
Mounting	Bolt down
Footprint (WxD)	124 mm x 149,5 mm

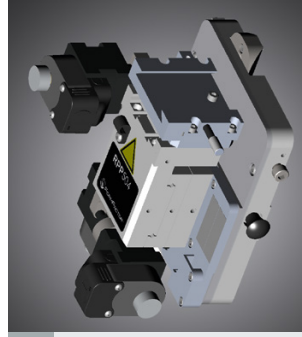



Industry-leading High-performance Probes Standard for On-wafer Measurement of mm and Sub-mm Wavelength Devices

Infinity Waveguide Probe

This component/on-wafer probing solution is designed to meet the challenges of high-frequency probing for advanced on-wafer modeling and characterization while providing low, stable contact resistance on 50 micron pads. The Waveguide Infinity



T-Wave Probe

The T-Wave Probes set the industry performance standard for characterization of mm-Wave devices.

- / Lowest insertion loss
- / Lowest contact resistance on Au pads
- / 140 GHz – 11 THz versions
- / Probe pitch as narrow as 25 μm
- / Lithographically-defined probe tip
- / Nickel contacts

Probe's new membrane GSG contact tip design reduces stray EM fields near probe tip. Control of EM fields near the tip allows repeatable measurements up to 500 GHz and improved crosstalk performance between the tips.

- / Probe loss is 3 dB typical between 140 and 200 GHz, S11/S22 15 dB typical
- / Reduced unwanted couplings and transmission modes
- / Able to shrink pad geometries to 25 x 35 μm (best case)
- / Lowest contact resistance on Al pads
- / WR15, WR12, WR10, WR8, WR6, WR4 and WR3 bands available

This probe delivers lowest insertion loss and contact resistance when probing gold pads. It has excellent tip visibility and enables characterization of devices up to 1.1 THz.

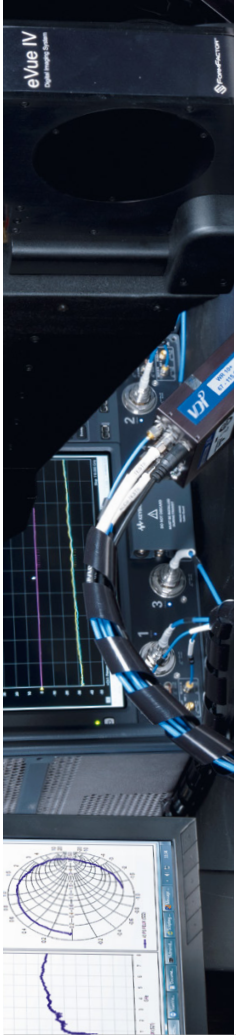

WinCal XE™ High-performance RF Calibration Software

Powerful RF Calibration

- Exclusive 1-, 2-, 3-, and 4-port calibration algorithms
- Immediate and live data measurement and viewing
- Error Set Management capability for data comparison and augmentation



LRRM™, LRRM™-SOLT, SOLT, SOLR, hybrid LRRM-SOLR and NIST-style multi-line TRL calibrations

Error Set Management capability for data comparison and augmentation

WinCal XE™ from FormFactor is a comprehensive and intuitive on-wafer RF measurement calibration tool to achieve accurate and repeatable S-parameter measurement, which is crucial for precision device modeling/characterization and engineering RFIC test.

WinCal XE is fully-integrated with Velox Probe Station Control Software: A two-way channel of

communication synchronizes probing processes with RF measurements and calibrations.

The WinCal XE features a guided system setup complete with customizable Wizards to ensure fast and easy access to reliable VNA calibration and repeatable data.

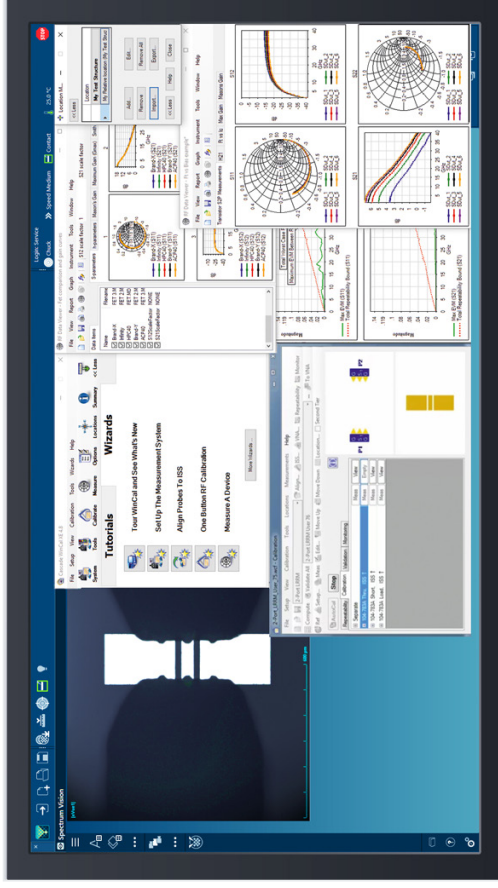

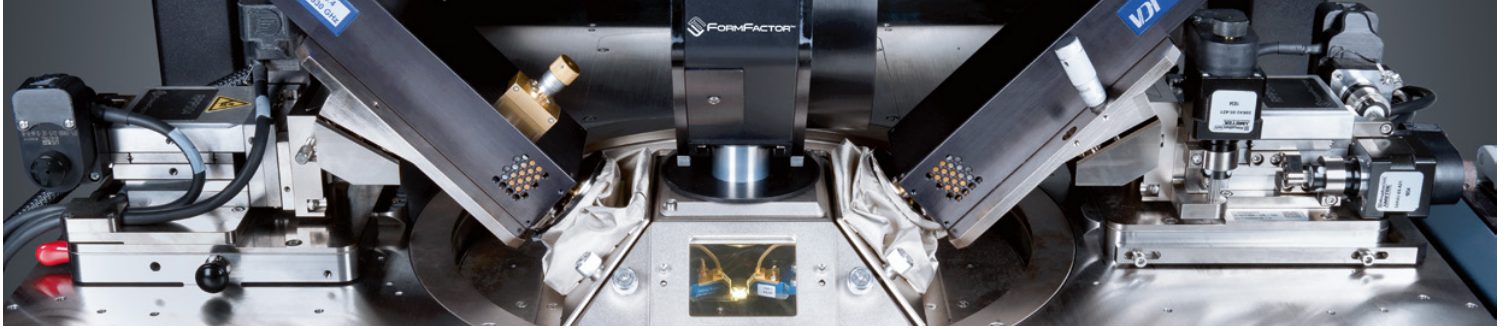

Available for Keysight N5291, all VDI mini Extenders from 50 GHz to 330 GHz, and more...

Works with Infinity and T-Wave 'S' type probes

Fits on CM300xi, SUMMIT200, Elite, Summit 11000/12000 and EPS150/200 probe stations

Compatible with eVue and SlimVue microscopes with 10X or 5X objectives

Lowest possible insertion loss

/ More raw directivity and dynamic range

Shortest measurement path

/ Less drift with temperature

Options for RF TopHat compatibility

/ Full thermal (-60 to +125° C)

/ Dark, shielded and frost free

Manual or programmable positioners

/ Programmable allows Auto TRL calibration

Autonomous RF compatible

/ Reduce cost of test and accelerate time to market
with true hands-free calibrations and measurements

Dove tail makes easy swapping between bands

/ Between N5291, WR5, WR3.4, etc.

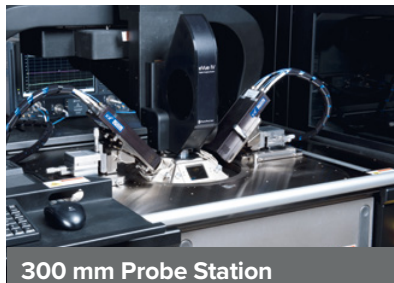

300 mm Probe Station

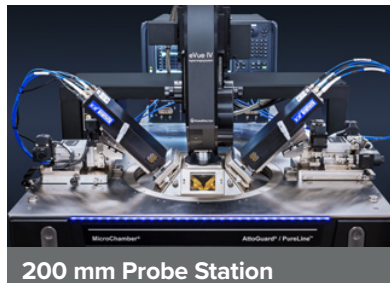

200 mm Probe Station

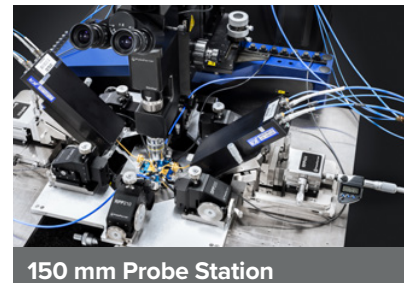

150 mm Probe Station

©Copyright 2021, FormFactor, Inc. All rights reserved. FormFactor and the FormFactor logo are trademarks of FormFactor, Inc. All other trademarks are the property of their respective owners.

All information is subject to change without notice.

BR-MMW-0221



www.formfactor.com



@formfactor



FormFactor Inc.