

# DF242

## Large Low Angle Dark Field Ring Lights Product Datasheet



### 3 Field-of-View Options

25mm, 35mm and 70mm field sizes are possible at time of order

### Superior Very Low Angle Light Geometry

Evenlite technology's precision LED aiming creates a very low-angle, thin, yet uniform projection

### M4 Mounting Points

Engineered with four opposing M4 mounting points for highly adjustable positioning

### Very Low Angle Dark Field

High Intensity LEDs with a focusing lens limited to medium angle Dark Field applications



## DF242 Series Description

The DF242 ring light is designed to function like the DF241 light in that it also produces a thin slice of light for very low angle surface defect detection. The positioning requirements and application envelope is similar to that of the DF241.

The DF242's larger diameter allows an additional LED aim that projects a 2x larger spot size on target compared with the DF241 light.

The DF242 ring light differs from the DF196 Dark Field light in similar fashion as the DF241. Namely, aimed LEDs, rather than a central focusing lens, that produces a relatively smaller spot projection at close working distance compared with medium angle Dark Field ring lights.



**Low Angle Dark Field Illumination**



**Moderate Intensity**



**6 Available Wavelengths**



**1-2 Week BTO Lead Times Typical**

**General Information**

**General Specifications**

Category	Specification	Detail			
<b>Optical</b>	Available Wavelengths	WHI, 395 nm, 470 nm, 520 nm, 625 nm, 880 nm			
	Available Lensing	No Lenses			
	Available Light Conditioning	None			
<b>Electrical</b>	Power Consumption Info	<a href="#">See Power Requirements on Page 8</a>			
	Cable Info	80" -0/+6" Long (2 m -0/+150 mm), 105 °C Rated, Foil Shield w/ Drain			
<b>Mechanical</b>	Sizing Info	Standard	Length	7.02"(178.3mm)	<a href="#">See Page 7 for More Details</a>
			Width	7.02"(178.3mm)	
			Height	0.56"(14.2mm)	
			Inner Diameter	4.78"(121.4mm)	
	Weight Info (Standard)	~ 1.21 lbs (~548 g) per Unit			
	Mounting Info	M4 Mounting Holes			
	Material Info	Anodized Aluminum Housing, Powder Coated Cold Rolled Steel, PVC Cable Jacket, Steel Black Oxide Fasteners			
<b>Thermal</b>	Operating Case Temperatures	25 °C to 60 °C			
	Operating Ambient Temperatures	0 °C to 35 °C			
<b>Certification</b>	Compliance	CE, RoHS, IEC 62471			
	IP Rating	Not Rated			
	Lumen Maintenance - White Only	L70 (50,000 Hours)			

**General Information - Continued**

**Part Number Key**

Model	-	Peak Wavelength	Illuminated Field of View (mm)	Connector/Control	-	Alternative Connector
DF242	-	XXX	XX	XX	-	XXX
DF242		395 (UV) <sup>2</sup>	35	C1		M8 <sup>1</sup>
		470 (blue)	45	C5		M12 <sup>1</sup>
		520 (green)	70	IC		
		625 (red orange)		I3		
		880 (IR)		I3S		
		WHI (white)		24		

more info on page

5

4

8

10

**Example Part Numbers:**

DF242-39545I3-M12  
DF242-52035C1

<sup>1</sup> Available with IC, I3, I3S, and 24 options only

<sup>2</sup> Not available in IC and 24 options

**In Stock**

Unavailable

**Lead Times**

Stock products ship within three days.  
Build-to-Order custom products ship within one to two weeks.

**Configurator**

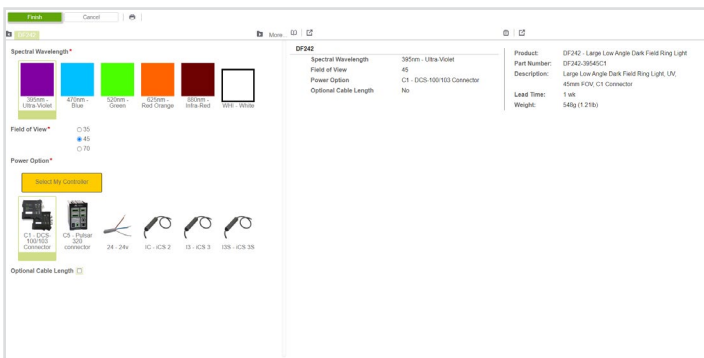

Need a build-to-order custom lighting solution in 2 weeks or less? Advanced Illumination's online configurator helps you tailor our DF242 Large Low Angle Dark Field Ring Lights to your specific needs. For a guided configuration, [visit our online configurator](#).

**Optical Information**

**Intensity Characteristics**

**Intensity Distribution at 25 mm Working Distance**

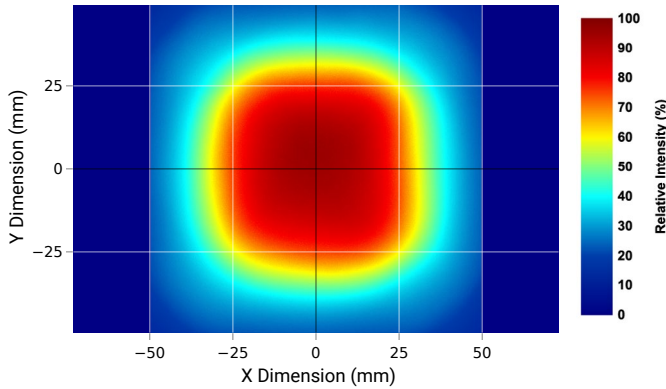

Intensity distribution sample image was taken with a DF242-WHI7013 unit.

**Intensity vs Working Distance**

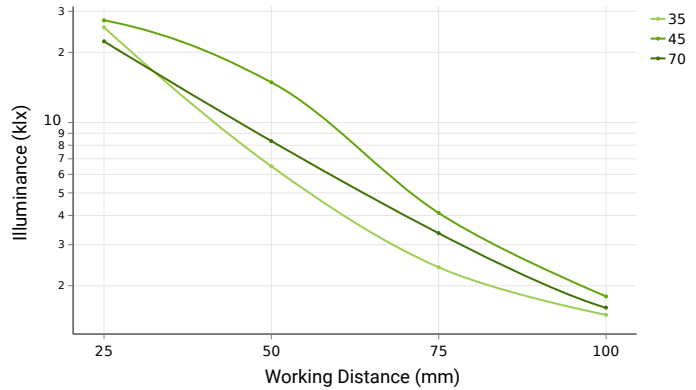

Illuminance data was collected using white DF242 units.

The DF242 produces an uniform intensity distribution over the part number specified illuminated FOV when placed at a 25 mm working distance. This is achievable with Advanced Illumination's proprietary LED aiming technique.

**Continuous vs Strobe Intensity**

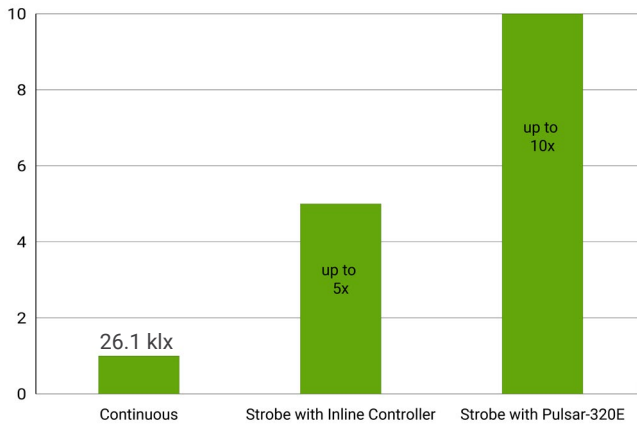

Under continuous operation, a DF242-WHI3513 unit will output an **illuminance of 26.1 klx** and an **irradiance of 93.1 W/m<sup>2</sup>** at a 25mm working distance. For applications that require higher output, the DF242 Series has been engineered to be overdrive strobe capable. When configured with AI's strobe enabled Inline Controller (ICS-3 and ICS-3S), the DF242 is capable of outputting up-to 5X continuous levels. When configured with a C5 connector, compatible with AI's Pulsar 320, a **DF242 can be strobed up-to 10X continuous intensity levels.**

Disclaimer: The measurements provided above are for approximations only and may vary depending on the method of measurement and the specific configuration being measured.

**Optical Information - Continued**

**White Spectral Profile**

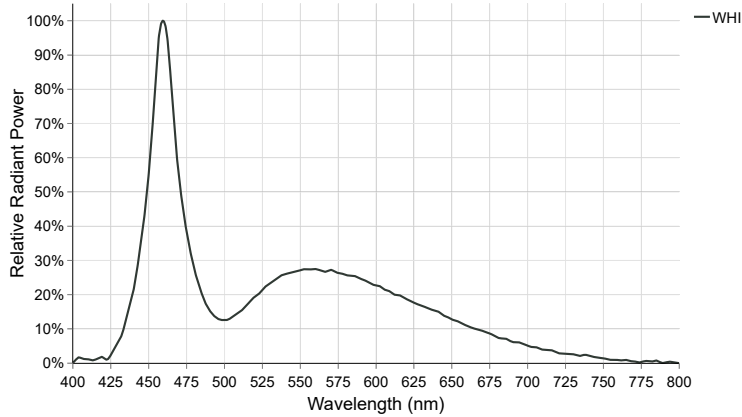

White LED illumination is the most commonly used machine vision lighting configuration. It is often the default choice when specific features of interest do not require color-based highlighting. However, white LEDs can vary in color temperature, which can impact machine vision systems, specifically when matching white light sources.

The DF242 Series white LEDs have a relatively cool color correlated temperature (CCT) of **6000 K**.

For a more detailed look at the white spectral data, download the [csv file of the raw spectral values](#) and refer to our [Product Spectra Distribution Charts PDF](#).

**Visible Spectral Profiles**

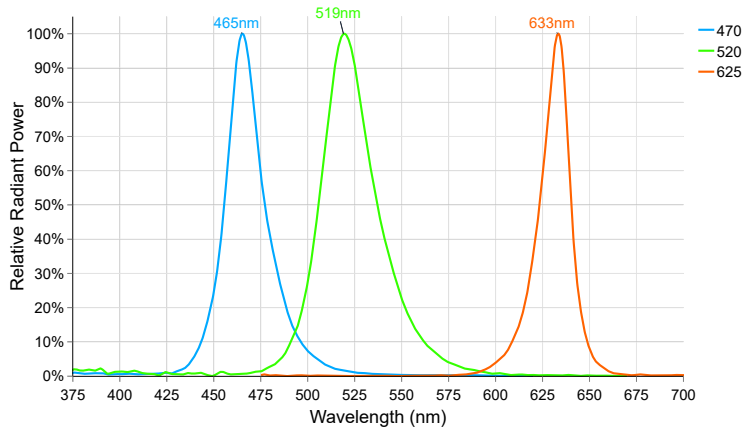

Visible color illumination consists of using wavelengths between 400-700 nm to either create or eliminate contrast on an inspection subject based on differences in a features color hue. When referring to a color wheel, simply remember the following: like colors reflect and brighten surfaces; conversely, opposing colors absorb and darken surfaces.

The DF242 Series is available in **470 nm, 520 nm, and 625 nm** configurations.

For a more detailed look at the visible color spectral data, download the [csv file of the raw spectral values](#) and refer to our [Product Spectra Distribution Charts PDF](#).

**Non-Visible Spectral Profiles**

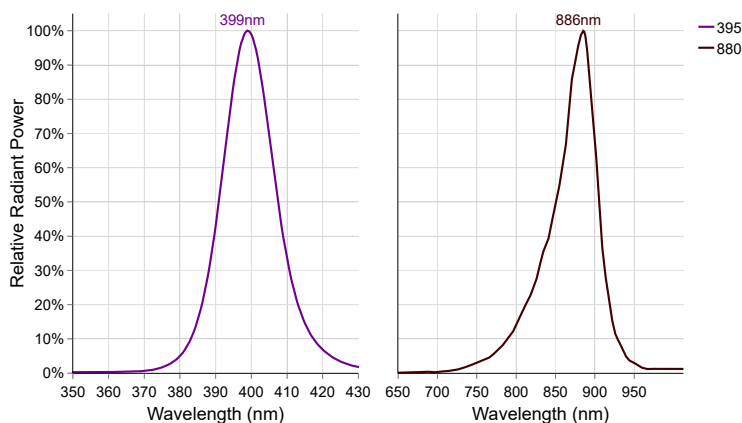

Near-infrared (NIR) imaging is a machine vision technique using longer wavelengths of 700-1000 nm to penetrate specific materials that are otherwise opaque to under the visible spectrum. When paired with a NIR camera, a NIR light can be ideal for applications such as fill level inspection, circuit board inspection, food safety inspection, and medical imaging.

The DF242 Series is available in **365 nm and 880 nm** configurations.

For a more detailed look at the NIR spectral data, download the [csv file of the raw spectral values](#) and refer to our [Product Spectra Distribution Charts PDF](#).

Disclaimer: The measurements provided above are for approximations only and may vary depending on the method of measurement and the specific configuration being measured.

**Optical Information - Continued**

**Photobiological Risk Factors**

Group	Description	Affected Wavelengths
Exempt	No Photobiological Hazard	880
Group 1	No Photobiological hazard under normal behavioral limitations	470, 520, 625, WHI
Group 2	Does not pose a hazard due to aversion response to bright light or thermal discomfort	395

Advanced Illumination’s lighting products have been tested and classified to IEC standards by accredited testing services. For more information on photobiological risk factors, please view the following PDF: <https://www.advancedillumination.com/wp-content/uploads/2019/04/IEC-040119.pdf>

**Cleaning Guidelines**



To clean our light’s optics, it is best to only clean when necessary. Dusting is always the first step in cleaning your optics. Wiping a dusty optic is like cleaning it with sandpaper. So always dust with a canned air duster or compressed and filtered air before wiping any optic. If the dusted optic has no visible stains after you dust it, then remember: “If it’s not dirty, don’t clean it.” Avoid wiping optics when possible.

If dusting did not clean the lens or the lens has stains, use only de-ionized water and mild dish soap with a low lint cloth designed for optics to avoid damage to the optic by any harsh chemicals.

Polarizers, beam splitters and collimated films should never be wiped with any type of cloth or solvent, only use the air dusting method to clean these types of optics.

The aluminum housing can be wiped down when dusting is not a sufficient means to thoroughly clean.

**Mechanical Information**

**Installation Drawings**

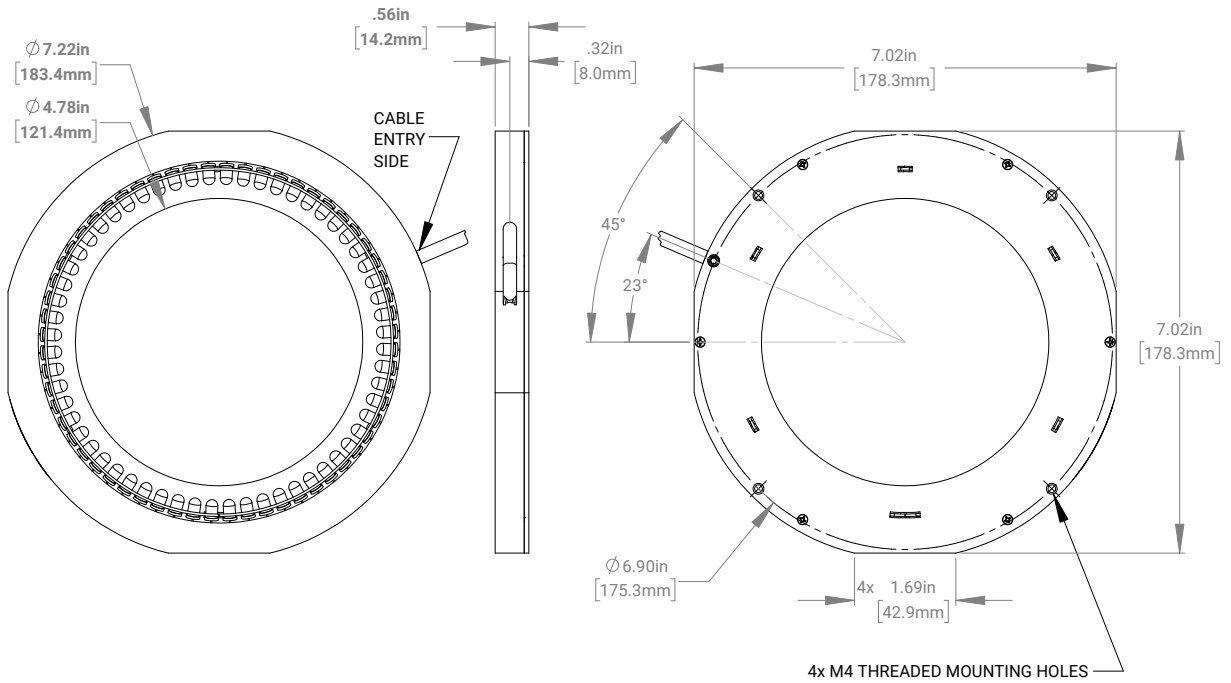

For full installation drawings and complete CAD models of this non-sealed configuration, please visit the [downloads section of the product webpage](#).

**Electrical Information**







**Power Requirements**

**Current Required for Power Supply Sizing**

Wavelengths (nm)	Configured w/ Voltage Drive (24)	Configured w/ Standard Controller (C1, C5, IC, I3, I3S)
WHI, 395, 470, 520	0.240A	0.180A
625, 880	0.360A	0.270A





Note: All Advanced Illumination lights and controllers are nominally powered by 24V DC unless otherwise noted. Strobe overdriving with controller based models may require more current and voltage overhead. The values above do not include background current draw from the controller (~100 mA total).

**Control Options**

Controller Image	Controller Details	Connector Image
	<p><b>DCS Single Output Controller - Compatible with C1 Configurations</b> PN: DCS-100E</p> <p>The DCS-100E is a compact, din-rail mounted general-purpose external controller with one C1 output connector, wired with three channels. Capable of providing single channel control or multi-channel control for RGB compatible lights.</p> <p><b>Output Power:</b> 90 W Max Continuous, 540 W Max Pulsed (Overdrive Strobe)  <b>Output Current:</b> 4.5A Max Continuous, 15 A Max Pulsed  <b>I/Os:</b> 3 External Trigger Inputs  <b>Interface:</b> 10/100 Ethernet with Software and browser-based GUIs. SDKs are also available.</p> <p>For more information about our DCS-100E, please <a href="#">visit the controller product page</a>.</p>	
	<p><b>DCS Triple Output Controller - Compatible with C1 Configurations</b> PN: DCS-103E</p> <p>The DCS-103E is a din-rail mounted general-purpose multi-light controller with three C1 output connectors. Capable of driving three lights in sync or asynchronously.</p> <p><b>Output Power:</b> 30 W Max Continuous / Output, 180 W Max Pulsed / Output  <b>Output Current:</b> 1.5A Max Continuous / Output, 5 A Max Pulsed / Output  <b>I/Os:</b> 3 External Trigger Inputs  <b>Interface:</b> 10/100 Ethernet with Software and browser-based GUIs. SDKs are also available.</p> <p>For more information about our DCS-103E, please <a href="#">visit the controller product page</a>.</p>	
	<p><b>Pulsar 320E High Current Controller - Compatible with C5 Configuration</b> PN: Pulsar 320E</p> <p>The Pulsar 320E is a high-power, dual output, pulse-only controller geared for overdriving driving lights at very short flash durations with very high current.</p> <p><b>Output Power:</b> 2500 W Max Pulsed / Output  <b>Output Current:</b> 50 A Max Pulsed / Output  <b>I/Os:</b> 2 External Trigger Inputs  <b>Interface:</b> 10/100 Ethernet with Software GUI. SDKs are also available.</p> <p>For more information about our Pulsar 320E, please <a href="#">visit the controller product page</a>.</p>	

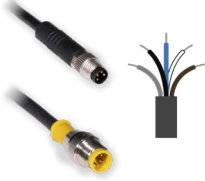
**Electrical Information - Continued**

**Control Options - Continued**

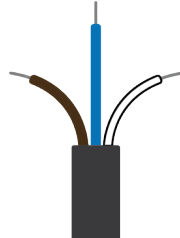
Controller Image	Controller Details	Connector Image
	<p><b>Inline Controller - Continuous Only - IC Configurations</b> <i>PN: N/A</i></p> <p>The IC is an inline, cable-mounted continuous-only controller configured/wired directly for the ordered light head.</p> <p><b>Output Power:</b> 25 W Max Continuous  <b>Output Current:</b> 1.25 A Max Continuous  <b>I/O:</b> 1 0-10 V Analog Dimming Input  <b>Interface:</b> Direct Cable (flying leads or optional connector)</p> <p>For more information about our IC Controller please <a href="#">visit the controller product page</a>.</p>	
	<p><b>Inline Controller - Strobe and Continuous - I3 &amp; I3S Configurations</b> <i>PN: N/A</i></p> <p>The I3 and I3S are inline, cable-mounted continuous and pulse (overdrive strobe) capable controllers configured/wired directly for the ordered light head. When operated in pulsed mode, the I3 is a default-on device on power up, whereas the I3S is default-off, requiring a trigger to illuminate.</p> <p><b>Output Power:</b> 25 W Max Continuous, 125 W Max Pulsed  <b>Output Current:</b> 1.25 A Max Continuous, 8 A Max Pulsed (Load Dependent)  <b>I/Os:</b> 1 Gated Trigger Signal, 1 0-10 V Analog Dimming Input  <b>Interface:</b> Direct Cable (flying leads or optional connector)</p> <p>For more information about our I3/I3S Controller, please <a href="#">visit the controller product page</a>.</p>	
	<p><b>24V Driver - Continuous Only - 24 Configurations</b> <i>PN: N/A</i></p> <p>24V option allows lights to operate continuous output with 24V connection and no additional controllers.</p> <p><b>Modes:</b> Continuous, can be wired to some 3rd party controllers or external relays for gated operation  <b>Interface:</b> Direct cable (flying leads or connector options)</p>	

**Electrical Information - Continued**

**Inline Control Option Wiring Information**

**Standard Flying Lead and Optional M12 Connector Pinout Functions**

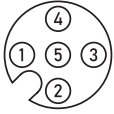
Pin (M12)	Wire Color	24V Functions	IC Functions	I3/I3S Functions	M12 Pinout
1	BROWN	24V DC	24V DC	24V DC	 <p>5-Position Male Connector</p>
2	WHITE	N/A	0-10V Analog Control	Reserved	
3	BLUE	DC GND	DC GND	DC GND	
4	BLACK	N/A	Gate Low	PNP/Active High Trigger	
5	GRAY	N/A	N/A	0-10V Analog Control	

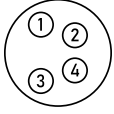

The functions above are only applicable when ordering an 24, IC, I3, I3s, or I4 power configuration with our without an M12 connector. For more wiring information pertaining to strobing and dimming functionality, please download the controller manuals and datasheets.

**Optional M8 Connector Pinout Functions**







Pin (M8)	Wire Color	24V Functions	IC Functions	I3/I3S Functions	M8 Pinout
1	BROWN	24V DC	24V DC	24V DC	 <p>4-Position Male Connector</p>
2	WHITE	N/A	0-10V Analog Control	Reserved	
3	BLUE	DC GND	DC GND	DC GND	
4	BLACK	N/A	Gate Low	Active High Trigger	

The functions above are only applicable when ordering an 24, IC, I3, or I3s power configuration with our without an M8 connector. For more wiring information pertaining to strobing and dimming functionality, please download the controller manuals and datasheets.

**Accessories**

Category	Accessory Image	Accessory Detail
Power Supply		<p><b>24 Volt DC Power Supply</b> PN: PS24-TL</p> <p>This convenient power source is a universal AC input switching power supply with a regulated output DC current. The power supply comes with an LED Power Indicator, tinned leads marked Positive (+) and Negative (-) and 2 WAGO connectors for simplified assembly.</p> <p>For more information about our 24 Volt DC Power Supply, please <a href="#">visit this webpage</a>.</p>
		<p><b>Manual Dimming Accessory for the IC, I3 and I3s</b> PN: DCS-MP</p> <p>The DCS-MP is a 30-position potentiometer, detented for precision level control and provides repeatable dimming with cable inline controllers. Features include DIN-rail mountable, a flip up cover to prevent accidental adjustments, spring clamp wiring terminal for flying leads or an M12 connector for use with the IC or I3/I3S Inline Controllers.</p> <p>For more information about our Manual Dimming Accessory please <a href="#">visit this webpage</a>.</p>
Dimmer		<p><b>Manual Dimming Accessory for the IC</b> PN: MP-ICS</p> <p>The MP-ICS is a dimmer which is designed for use on lights with the IC Inline Controller. This unit provides for 0 – 100% intensity control. It is NOT COMPATIBLE with LLI37, BLI38, LLI67, and BLI68 "IC" Lights or lights built with the "24v controller" option.</p> <p>For more information about our Manual Dimming Accessory, please <a href="#">visit this webpage</a>.</p>

**Accessories - Continued**

Category	Accessory Image	Accessory Detail
Extension Cable		<p><b>DCS-100E/103E Extension Cable, Single Light Power Cable - C1 Configuration</b> PN: LC-XX-S</p> <p>This extension cable was designed for applications requiring power cables longer than the standard 2 meters provided with Ai lights. This single light cable features a single male and single female 7 pin locking connector (C1) and can be purchased in 3 - 15-meter lengths.</p> <p>For more information about our DCS-100E/103E Extension Cable, Single Output, please <a href="#">visit this webpage</a>.</p>
Extension Cable		<p><b>DCS-100E/103E Extension Cable, Dual Light Power Cable - C1 Configuration</b> PN: LC-XX-Y</p> <p>This extension cable was designed for applications requiring two identical lights to be powered through a single controller. These Y cables feature a single male and dual female 7 pin locking connectors (C1) and can be purchased in 3 - 15-meter lengths. See attached spec sheet for compatible light configuration.</p> <p>For more information about our DCS-100E/103E Extension Cable, Split Output, please <a href="#">visit this webpage</a>.</p>
Extension Cable		<p><b>Pulsar 320E Extension Cable - C5 Configuration</b> PN: LC-XX-S-C5</p> <p>This extension cable was designed for applications requiring power cables longer than the standard 2 meters provided with Ai lights. This single light cable features a single male and single female Pulsar 320 connector (C5) and can be purchased in 3 - 15 meter lengths.</p> <p>For more information about our Pulsar 320E Extension Cable, please <a href="#">visit this webpage</a>.</p>
Adaptor Cable		<p><b>Cognex Gen2 Inline Controller Adaptor Cable</b> PN: AD-I3-CGX2</p> <p>This cable adaptor is for connecting I3/I3S configured lights with Cognex Gen2 Cameras, and comes with a male to female M12 connectors.</p> <p>For more information about our Cognex Gen2 Inline Controller Adaptor Cable, please <a href="#">visit this webpage</a>.</p>
Filters		<p><b>Camera Lens Band Pass Filters</b> PN: BPXXX-YYY</p> <p>Eliminating all but a narrow band of light (+/- 40nm) centered on the specified wavelength, band pass filters are used to enhance colors, or to stop unwanted ambient light from reaching the camera. Filtering can replace existing shrouds, simplifying the physical set up of an inspection site. Ai offers 635nm and 660nm band pass filters to fit several different lens sizes.</p> <p>For more information about our Camera Lens Band Pass Filters, please <a href="#">visit this webpage</a>.</p>
Mounting Brackets		<p><b>Mounting Brackets</b> PN: LB</p> <p>For mounting purposes this product is compatible with Fastens to the M4 mounting channel for simplified mounting. Included in product purchase.</p> <p>For more information about our Mounting Brackets, please <a href="#">visit this webpage</a>.</p>

### Additional Information

#### Warranty

Every Advanced illumination, Inc. (Ai) product is thoroughly inspected and tested before leaving the factory. Products are warranted to be free of defects in workmanship and materials for a period of FIVE YEARS from the original date of purchase. Should a defect develop during this period, customers may return the complete product, freight prepaid, to one of Ai's distributors or to the Ai factory. All product warranty returns require a Return Merchandise Authorization (RMA) number which is obtained from Customer Service. The RMA number must be clearly marked on the outside of the package. Ai will inspect the unit, and if a defect is found will, at our option, repair or replace the product without charge. Ai disclaims liability for any implied warranties, including implied warranties of "merchantability" and "fitness for a specific purpose." For products under warranty that have since been discontinued, Ai will make an effort to replace with equivalent parts; for circumstances that do not allow for equivalent replacement, Ai reserves the right to repair or replace these products with an updated version. Ai cannot be held responsible for the unauthorized or inappropriate use of its products. Any unauthorized repair or modifications will result in a voided warranty. No Liability for Consequential Damages: In no event shall Ai be liable for any consequential, special, incidental, or indirect damages of any kind arising from the sale or use of the products.

#### Compliance

Our lighting products are designed and tested to meet CE, RoHS, and IEC standards. As a global ISO 9001 certified company, we understand the importance of compliance and perform accelerated testing on every product before shipment. For more information on our compliance standards, please see our compliance documentation here: <https://www.advancedillumination.com/services/compliance-statements/>

#### Electromagnetic Compatibility

This product was tested and complies with the regulatory requirements and limits for electromagnetic compatibility (EMC) as stated in the product specifications. These requirements and limits are designed to provide reasonable protection against harmful interference only when the product is operated in its intended industrial electromagnetic environment. To minimize the potential for electromagnetic interference or unacceptable performance degradation, install and use this product in strict accordance with the instructions in the product documentation.

#### Customer Service

For information on existing orders, or to make an order adjustment, contact us Monday through Friday 8:00 am to 5:00 pm ET or send an email to [orders@advancedillumination.com](mailto:orders@advancedillumination.com).

#### Company Information

Advanced Illumination  
440 State Garage Road, Rochester, VT 05767  
Phone: +1 (802) 767 3830  
Fax: +1 (802) 767 2636  
Email: [info@advancedillumination.com](mailto:info@advancedillumination.com)  
Web: [advancedillumination.com](http://advancedillumination.com)  
© 2023 Advanced illumination Inc. All rights reserved