

BL313 Series

Medium Intensity Linear Backlights Product Datasheet

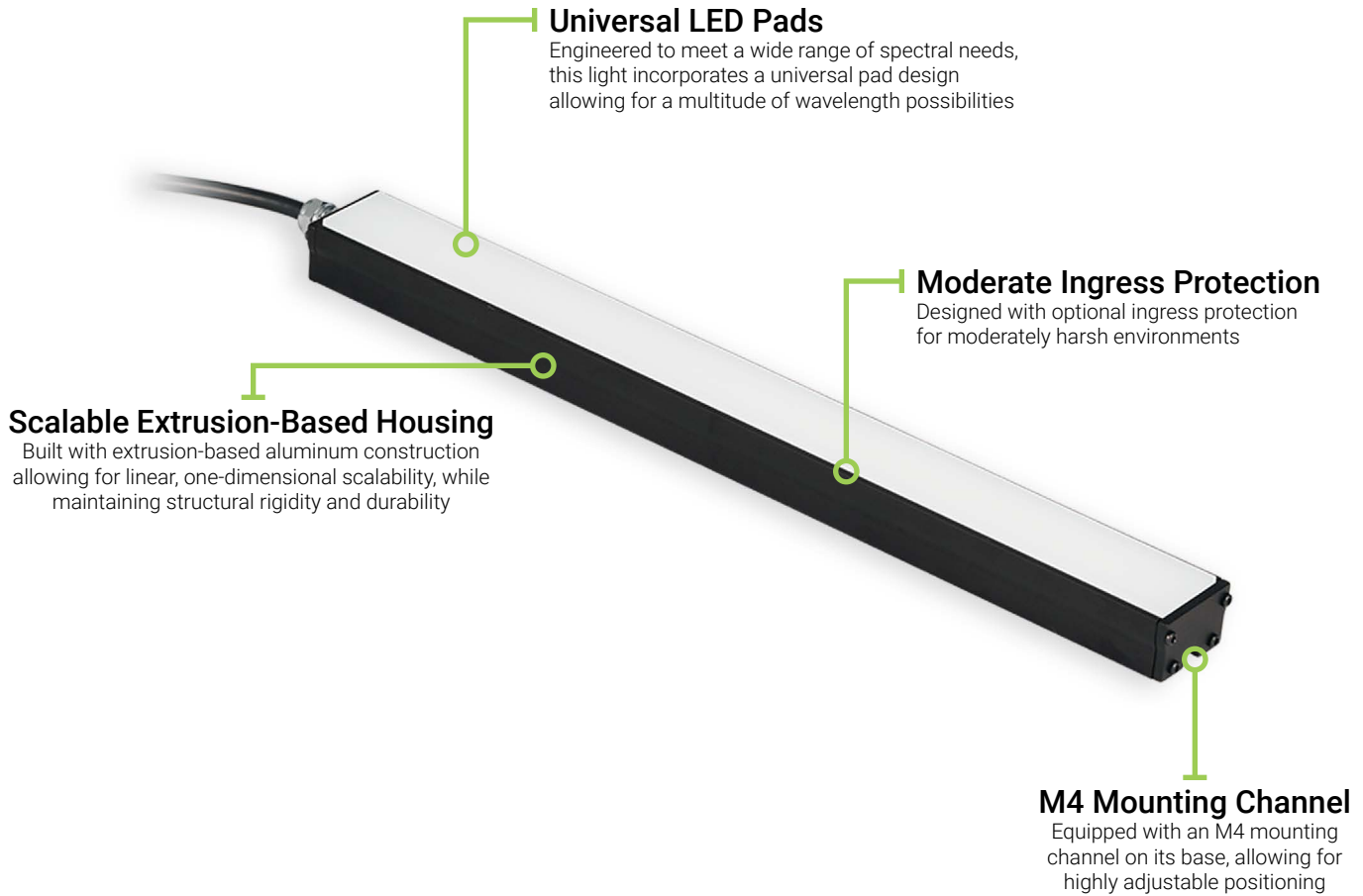

BL313 Series Description

The BL313 Series is a group of versatile linear light sources capable of producing highly diffuse illumination for a wide range of applications.

These uniform backlights can be used behind the object of interest for line scan applications or as non-directional bar light illuminators for more diffuse general-purpose machine vision lighting.

As with all Advanced illumination products, this series is built for customizability while maintaining best-in-class build-to-order lead times of only one to two weeks.



Medium Intensity



Scalable Design



8 Available Wavelengths



Multiple Control Options



1-2 Week BTO Lead Times Typical

General Information

General Specifications

Category	Specification	Detail			
Optical	Available Wavelengths	White, 455 nm, 470 nm, 530 nm, 590 nm, 625 nm, 850 nm, 940 nm			
	Available Lensing	No Lenses			
	Available Light Conditioning	None			
Electrical	Power Consumption Info	See Power Requirements on Page 10			
	Cable Info	80" -0/+6" Long (2 m -0/+150 mm), 105 °C Rated, Foil Shield w/ Drain			
Mechanical	Sizing Info	Standard	Length	3.15"(80.1mm) to 21.15"(537.2mm)	See Page 8 for More Details
			Width	1.27"(32.2mm)	
			Height	.85"(21.7mm)	
	Sealed	Length	3.31"(84.1mm) to 21.31"(541.3mm)		
		Width	1.27"(32.2mm)		
		Height	.85"(21.7mm)		
Weight Info (Standard)		~ 0.47 lbs (~213 g) per 4" Unit Length			
Mounting Info		M4 Mounting Nut Channel			
Material Info		Anodized Aluminum Housing, Acrylic Window, Nickel Plated Brass Strain Relief, PVC Cable Jacket, Steel Black Oxide, Optional: Silicone Sealant, Neoprene Gasket/ Buna-N Rubber O-Rings			
Thermal	Operating Case Temperatures	25 °C to 60 °C			
	Operating Ambient Temperatures	0 °C to 35 °C			
Certification	Compliance	CE, RoHS, IEC 62471			
	IP Rating	IP50 and IP65			
	Lumen Maintenance - White Only	L70 (50,000 Hours)			

General Information - Continued

Part Number Key

Model	Emitting Length (in)	-	Peak Wavelength	Connector/Control	Washdown Option	-	Alternative Connector
BL313	XX	-	XXX	XX	X	-	XXX
BL313	02" increments from 02" to 20"		455 (royal-blue)	C1	W (IP65)		M8 ¹
			470 (blue)	C5			M12 ¹
			530 (green)	IC			
			590 (amber)	I3			
			625 (red-orange)	I3S			
			850 (IR)	I4			
			940 (IR)	24			
			WHI (white)				
more information on page	8		5	10			12

Example Part Numbers:

BL31312-530IC-M12
BL31308-WHIC1W

¹ Available with IC, I3, I3S, I4 and 24 V

In Stock

Unavailable

Lead Times

Build-to-Order products ship within one to two weeks (typical).

Configurator

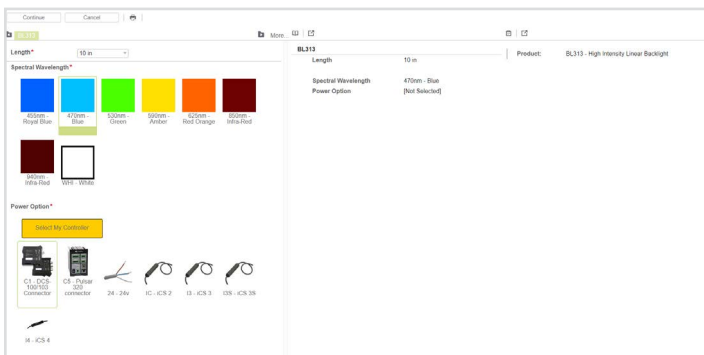

Need a build-to-order custom lighting solution in 2 weeks or less? Advanced Illumination's online configurator helps you tailor our BL313 Medium Intensity Linear Backlight Series to your specific needs. For a guided configuration, [visit our online configurator](#).

Optical Information

Intensity Distribution

Back Illumination

(imaging into emitting window)

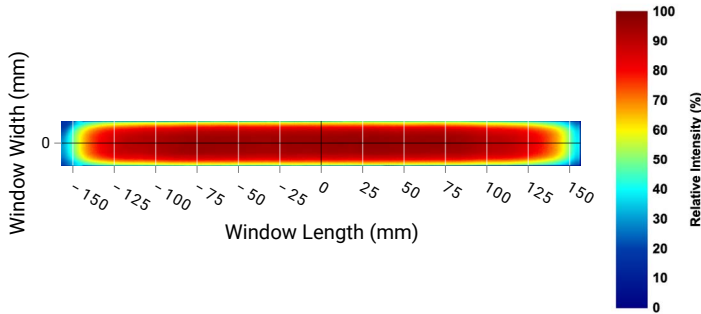

Front Illumination

(imaging emission at 100 mm working distance)

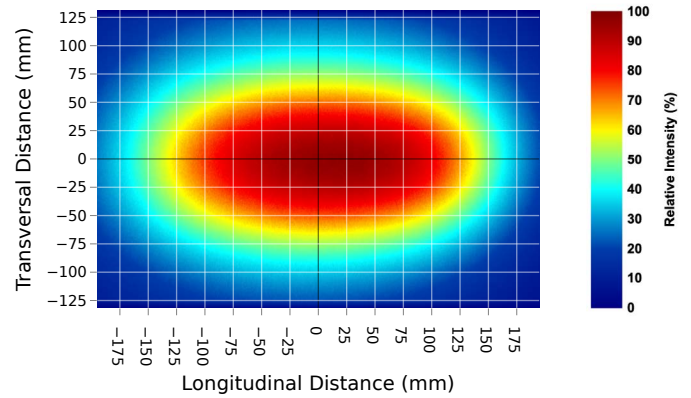

Both intensity distribution images shown above have been taken using a 12-inch white BL313 unit (BL31312-WHIIC).

FWHM vs Working Distance

Transversal FWHM vs Working Distance

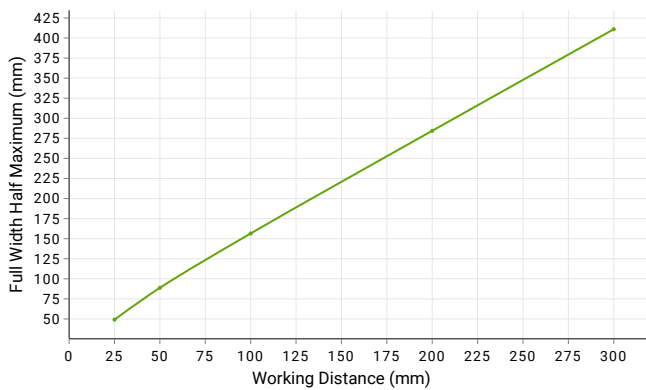

Longitudinal FWHM vs Working Distance

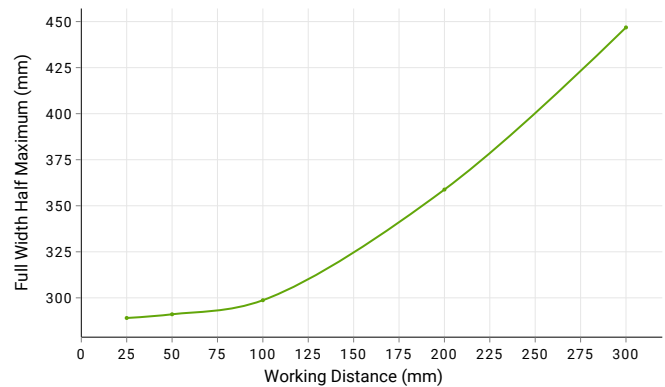

Both Full Width Half Maximum (FWHM) vs Working Distance plots shown above have been measured using a 12-inch white BL313 unit (BL31312-WHIIC).

Intensity vs Working Distance

Illuminance vs Working Distance

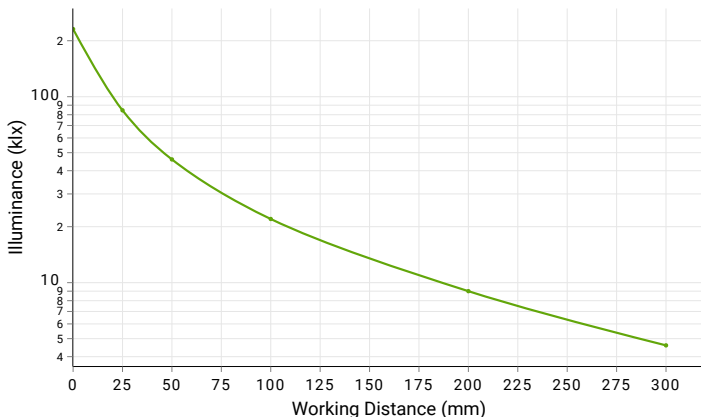

Linear Backlights, while typically oriented behind the object of interest, can also be used for highly diffuse front illumination at short to medium working distances. The chart to the left shows the BL313's intensity as it's distance from the inspection surface changes.

Disclaimer: The measurements provided above are for approximations only and may vary depending on the method of measurement and the specific configuration being measured.

Optical Information - Continued

Continuous vs Pulsed Intensity

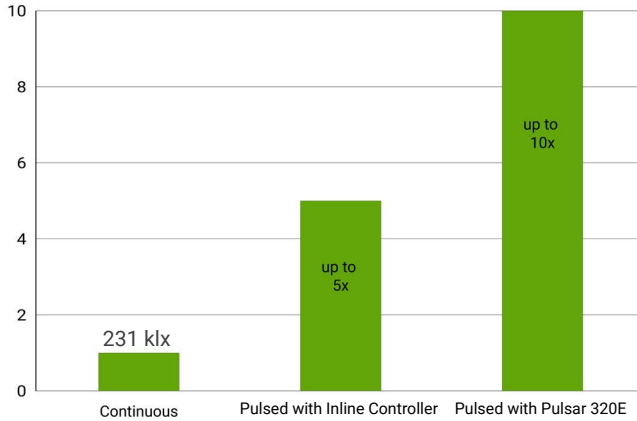

Under continuous operation, a 12-inch white BL313 unit will output an **illuminance of 231 klx** and an **irradiance of 735 W/m²** at the emitting surface. For applications that require higher output, the BL313 Series has been engineered to be overdrive strobe capable, otherwise known as pulsed mode. When configured with AI's strobe enabled Inline Controller (IC, I3 or I3S), the BL313 is capable of outputting up-to 5X continuous levels. When configured with a C5 connector, compatible with AI's Pulsar 320, a BL313 can be strobed up-to 10X continuous intensity levels.

White Spectral Profile

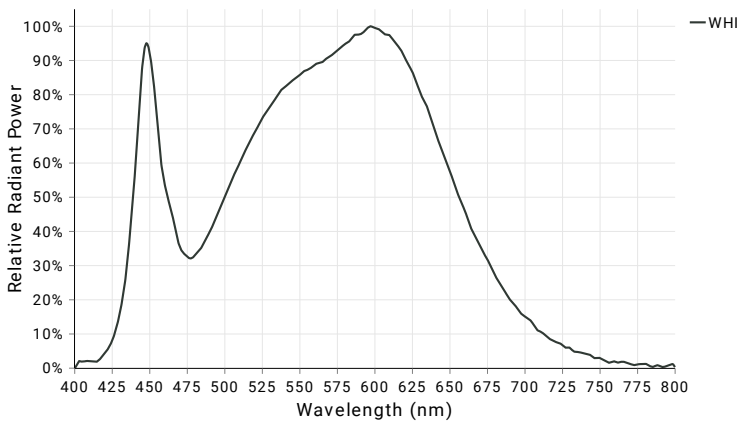

White LED illumination is the most commonly used machine vision lighting configuration. It is often the default choice when specific features of interest do not require color-based highlighting. However, [white LEDs can vary in color temperature between different lighting families, which can impact machine vision systems](#), specifically when matching white light sources.

The BL313 Series white LEDs have a relatively neutral color correlated temperature (CCT) of **5500 K**.

For a more detailed look at the white spectral data, download the [csv file of the raw spectral values](#) and refer to our [Product Spectra Distribution Charts PDF](#).

Visible Color Spectral Profiles

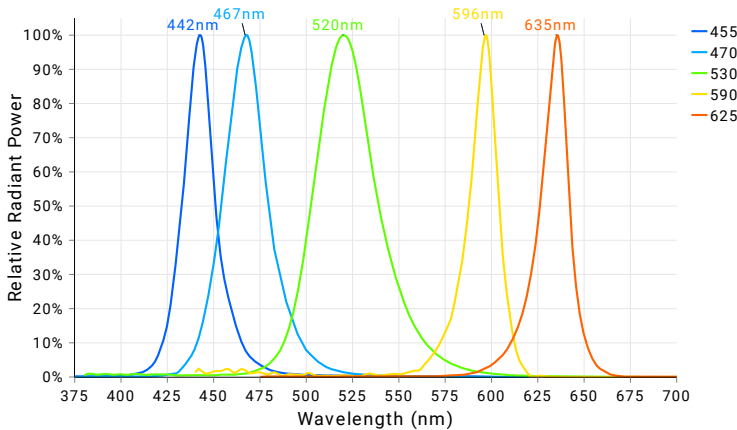

Visible color illumination consists of using wavelengths between 400-700 nm to either create or eliminate contrast on an inspection subject based on differences in a features color hue. When referring to a color wheel, simply remember the following: like colors reflect and brighten surfaces; conversely, opposing colors absorb and darken surfaces.

The BL313 Series is available in **455 nm, 470 nm, 530 nm, 590 nm, and 625 nm** configurations.

For a more detailed look at the visible color spectral data, download the [csv file of the raw spectral values](#) and refer to our [Product Spectra Distribution Charts PDF](#).

Disclaimer: The measurements provided above are for approximations only and may vary depending on the method of measurement and the specific configuration being measured.

Optical Information - Continued

Non-Visible Spectral Profiles

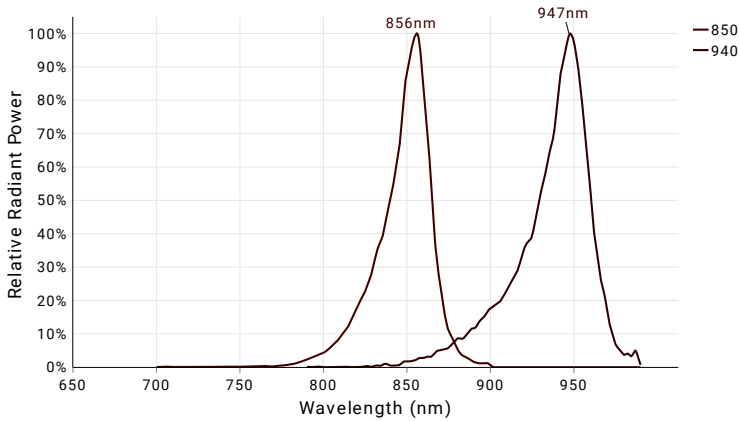

Near-infrared (NIR) imaging is a machine vision technique using longer wavelengths of 700-1000 nm to penetrate specific materials that are otherwise opaque to under the visible spectrum. When paired with a NIR camera, a NIR light can be ideal for applications such as fill level inspection, circuit board inspection, food safety inspection, and medical imaging.

The BL313 Series is available in **850 nm and 940 nm** configurations.

For a more detailed look at the NIR spectral data, download the [csv file of the raw spectral values](#) and refer to our [Product Spectra Distribution Charts PDF](#).

Photobiological Risk Factors

Group	Description	Affected Wavelengths
Exempt	No Photobiological Hazard	850 nm, 940 nm
Group 1	No Photobiological hazard under normal behavioral limitations	455 nm, 470 nm, 530 nm, 590 nm, 625 nm
Group 2	Does not pose a hazard due to aversion response to bright light or thermal discomfort	White

Advanced Illumination's lighting products have been tested and classified to IEC standards by accredited testing services. For more information on photobiological risk factors, please view the following PDF: <https://www.advancedillumination.com/wp-content/uploads/2019/04/IEC-040119.pdf>

Cleaning Guidelines



To clean our light's optics, it is best to only clean when necessary. Dusting is always the first step in cleaning your optics. Wiping a dusty optic is like cleaning it with sandpaper. So always dust with a canned air duster or compressed and filtered air before wiping any optic. If the dusted optic has no visible stains after you dust it, then remember: "If it's not dirty, don't clean it." Avoid wiping optics when possible.

If dusting did not clean the lens or the lens has stains, use only de-ionized water and mild dish soap with a low lint cloth designed for optics to avoid damage to the optic by any harsh chemicals.

Polarizers, beam splitters and collimated films should never be wiped with any type of cloth or solvent, only use the air dusting method to clean these types of optics.

The aluminum housing can be wiped down when dusting is not a sufficient means to thoroughly clean.

Backlight Comparison Matrix

Not finding the optical specifications you are looking for with the BL313 Series? Refer to the backlight comparison matrix below to compare and contrast Advanced Illumination's comprehensive product offering:

Attributes	Planar Backlights				Linear Backlights / High Diffusion Bar Lights				
	BL2	BX2	BT	BL245	BL313	BL138	BL168	BL128	BL193
Emitting Window Surface Intensity	86 klx	72 klx	48 klx (100 mm x 100 mm unit)	86 klx	231 klx	542 klx	567 klx	51 klx	12 klx
	249 W/m ²	229 W/m ²	137 W/m ² (100 mm x 100 mm unit)	249 W/m ²	735 W/m ²	1,642 W/m ²	1,760 W/m ²	173 W/m ²	41 W/m ²
Emitting Window Surface Edge Effect	0.681 in (17.3 mm)	0 in (0mm) (smaller models)	0 in (0mm)	0.724in (18.4mm)	0.987in (25.1mm)	0.343in (8.7mm)	0.429in (10.9mm)	0.634in (16.1mm)	1.524in (38.7mm)
100 mm Working Distance Intensity	N/A	N/A	N/A	N/A	22 klx	48 klx	50 klx	9 klx	1 klx
					74 W/m ²	153 W/m ²	164 W/m ²	32 W/m ²	4 W/m ²
100 mm Working Distance FWHM	Longitudinal: ~12 in (~300 mm) Transversal: ~6 in (~150 mm)								
Minimum Bezel Thickness	0.465 in (11.8 mm)	1.07 in (27.2 mm)	0.380 in (9.65 mm)	0.215 in (5.46 mm)	0.125 in (3.18 mm)	0.050 in (1.27 mm)	0.050 in (1.27 mm)	0.00 in (0.00 mm)	0.065 in (1.65 mm)
Maximum Light Thickness	0.940 in (23.9 mm)	0.75 in (19.0 mm)	0.420 in (10.7 mm)	0.950 in (24.1 mm)	0.850 in (21.6 mm)	3.570 in (90.7 mm)	3.570 in (90.7 mm)	0.480 in (12.2 mm)	1.180 in (30.0 mm)
Largest Possible Emitting Window Length	46 in (1168 mm)	24 in (610 mm)	8 in (204 mm)	12 in (305 mm)	20 in (508 mm)	96 in (2438 mm)	96 in (2438 mm)	14 in (356 mm)	80 in (2032 mm)
Sizes Available	736	484	3	144	10	17	17	14	80
Visible Wavelengths Available	4	8	4	4	6	4	1	4	4
IR Wavelengths Available	1	3	1	1	2	1	0	1	1
RGB Available	No	No	No	No	No	Yes	No	No	No
Collimation Available	Yes	Yes	Yes	No	No	No	No	No	No
Polarization Available	Yes	Yes	Yes	No	No	No	No	No	No
IP Rating	IP50	IP50	IP50	IP69K Certified	IP50	IP50	IP50	IP50	IP50
Price	\$\$\$	\$\$	\$\$\$	\$\$\$\$	\$\$	\$\$\$	\$\$\$	\$\$\$	\$

To ensure consistent comparisons, all data presented above is based on 12-inch white LED models unless explicitly stated otherwise. This corresponds to 12 inches by 12 inches (300 mm x 300 mm) in length as well as width for planar backlights and 12 inches in length for linear backlights. Additionally, all measurements provided above are derived from "standard" configurations, excluding sealed models if available as optional.

If you are still not finding the optical specifications needed for your application, [inquire](#) about our semi-custom and full-custom capabilities.

Backlight Comparison Matrix - Definitions

For definitions on the terminology used on the previous page, please refer to the table below:

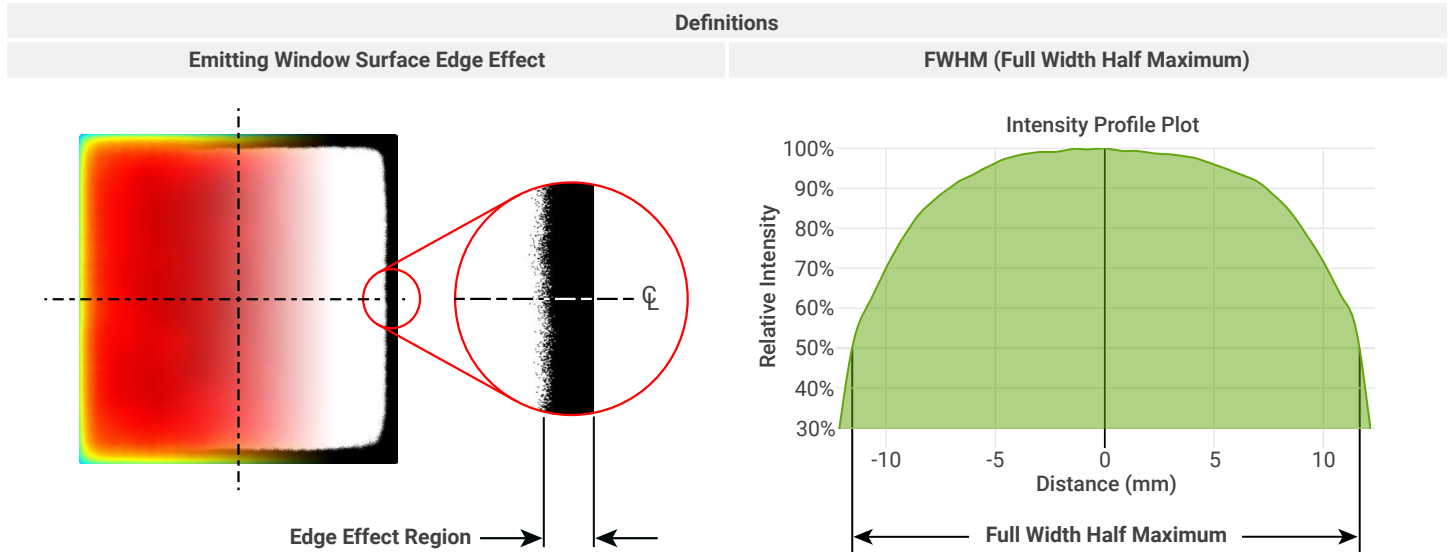

Edge Effect refers to the decrease in light intensity along the outer perimeter of a backlight's emitting surface. It's characterized by the region where the intensity falls below 80% of the peak value. For linear backlights, edge effect is measured along the length of the light. We recommend users avoid this region when sizing a backlight for their application.

FWHM (Full Width Half Maximum) is a measure of the width of a light source's intensity distribution. Specifically, it defines the distance between the points on the intensity profile where the light intensity drops to 50% of its peak value. This FWHM distance is often used to determine the usable FOV (Field of View) when aiming a light at a surface for inspection.

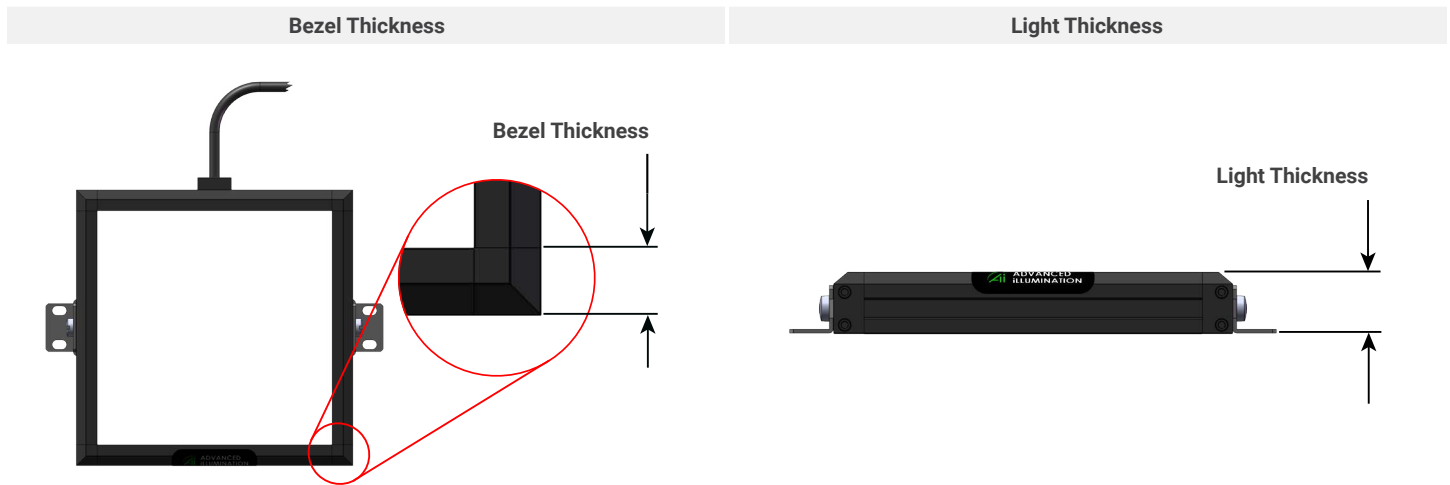

Bezel Thickness refers to the width of the non-illuminated border or frame surrounding the light-emitting surface of a machine vision backlight. Bezel thickness is an important consideration when integrating a backlight into a tight space, as it directly affects how close you can place the light-emitting surface to an object on its side.

Light Thickness refers to the overall depth of a machine vision backlight, measured from the back of the unit to the front of the light-emitting surface. A thinner light thickness is critical in applications with limited space constraints, allowing flexible integration into tight machine vision setups.

Disclaimer: The measurements provided above are for approximations only and may vary depending on the method of measurement and the specific configuration being measured.

Mechanical Information

Installation Drawings

Non-Sealed Configuration

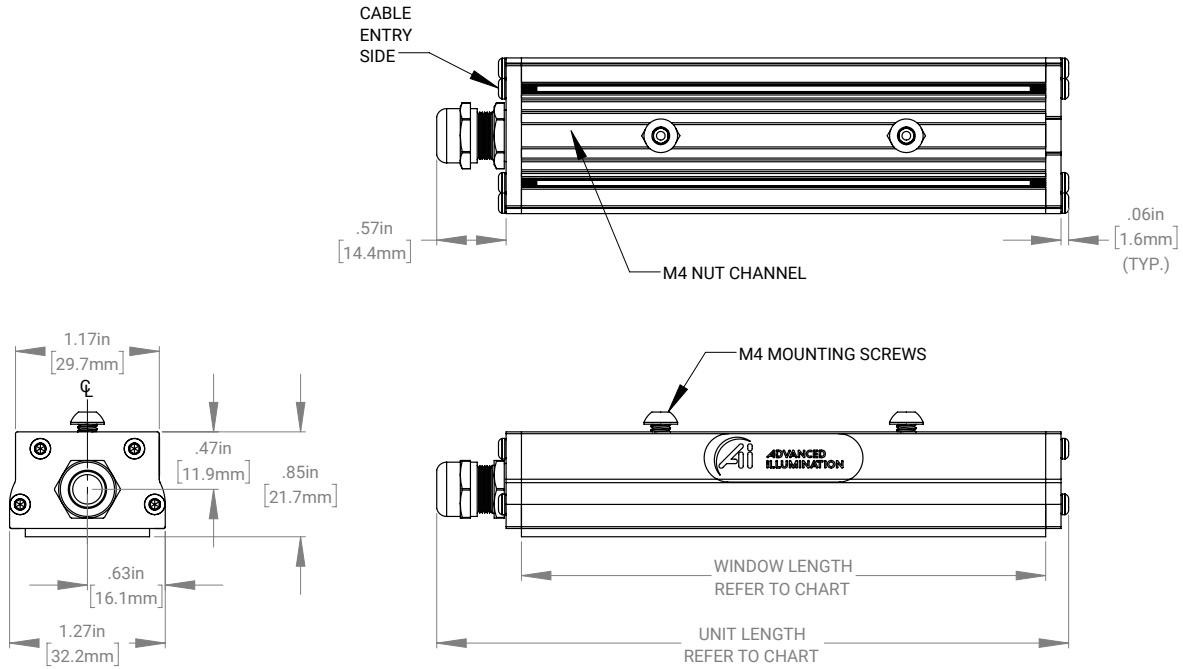

Sealed Configuration

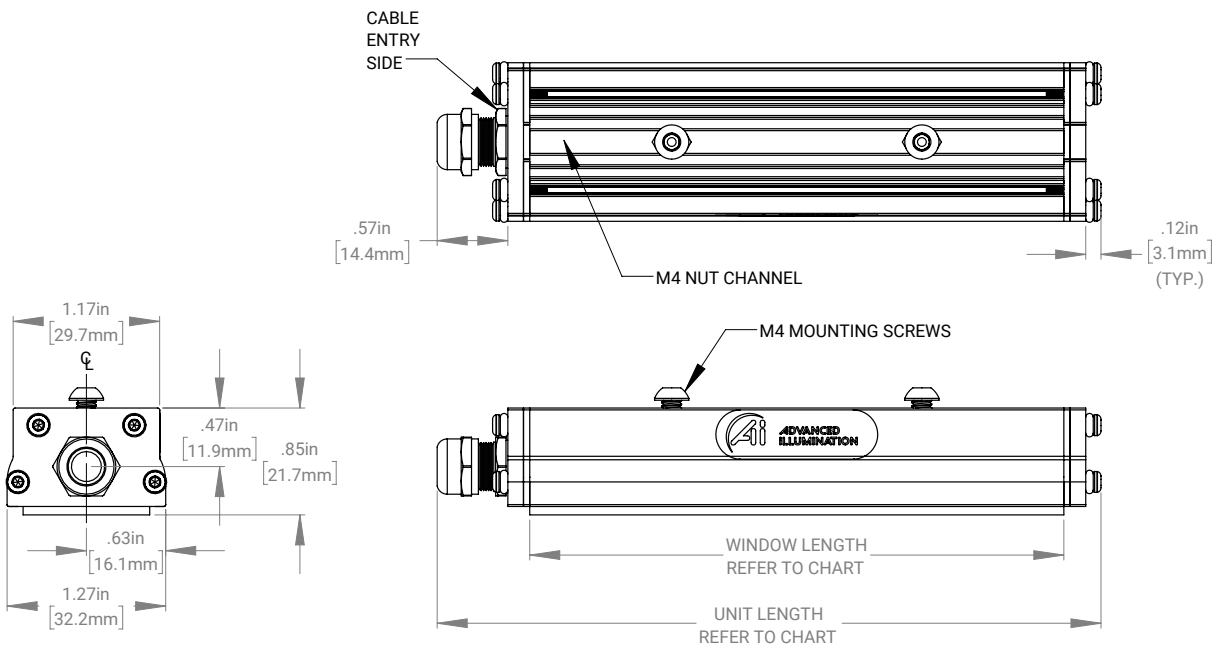

For full installation drawings and complete CAD models of this sealed configuration, please visit the [downloads section of the product webpage](#).

Mechanical Information - Continued

Sizing Chart

Part Number	Length (Inches)				Length (Millimeters)			
	Non-Washdown		Washdown		Non-Washdown		Washdown	
	Unit	Window	Unit	Window	Unit	Window	Unit	Window
BL13802	3.15	2.27	3.31	2.27	80.01	57.658	84.07	57.658
BL13804	5.15	4.27	5.31	4.27	130.81	108.458	134.87	108.458
BL13806	7.15	6.27	7.31	6.27	181.61	159.258	185.67	159.258
BL13808	9.15	8.27	9.31	8.27	232.41	210.058	236.47	210.058
BL13810	11.15	10.27	11.32	10.27	283.21	260.858	287.27	260.858
BL13812	13.15	12.27	13.31	12.27	334.01	311.658	338.07	311.658
BL13814	15.15	14.27	15.31	14.27	384.81	362.458	388.87	362.458
BL13816	17.15	16.27	17.33	16.27	435.61	413.258	439.67	413.258
BL13818	19.15	18.27	19.31	18.27	486.41	464.058	490.47	464.058
BL13820	21.15	20.27	21.31	20.27	537.21	514.858	541.27	514.858

Electrical Information







Power Requirements

Current Required for Power Supply Sizing







Wavelengths	Unit Size	Configured w/ Voltage Drive (24)	Configured w/ Standard Controller (IC, I3, I3S, I4, C1, C5)
WHI, 455 nm, 470 nm, 530 nm, 590 nm, 625 nm, 850 nm, 940 nm	1" to 12"	0.120 A per linear inch	0.240 A per linear inch
WHI, 455 nm, 470 nm, 530 nm, 590 nm, 625 nm, 850 nm, 940 nm	13" or Longer	0.090 A per linear inch	0.180 A per linear inch

Note: All Advanced Illumination lights and controllers are nominally powered by 24V DC unless otherwise noted. Strobe overdriving with controller based models may require more current and voltage overhead. The values above do not include background current draw from the controller (~100 mA total).

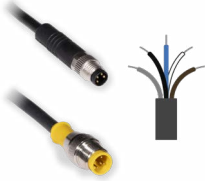
Control Options

Controller Image	Controller Details	Connector Image
	<p>DCS Single Output Controller - Compatible with C1 Configurations PN: DCS-100E</p> <p>The DCS-100E is a compact, din-rail mounted general-purpose external controller with one C1 output connector, wired with three channels. Capable of providing single channel control or multi-channel control for RGB compatible lights.</p> <p>Output Power: 90 W Max Continuous, 540 W Max Pulsed (Overdrive Strobe) Output Current: 4.5A Max Continuous, 15 A Max Pulsed I/Os: 3 External Trigger Inputs Interface: 10/100 Ethernet with Software and browser-based GUIs. SDKs are also available.</p> <p>For more information about our DCS-100E, please visit the controller product page.</p>	
	<p>DCS Triple Output Controller - Compatible with C1 Configurations PN: DCS-103E</p> <p>The DCS-103E is a din-rail mounted general-purpose multi-light controller with three C1 output connectors. Capable of driving three lights in sync or asynchronously.</p> <p>Output Power: 30 W Max Continuous / Output, 180 W Max Pulsed / Output Output Current: 1.5A Max Continuous / Output, 5 A Max Pulsed / Output I/Os: 3 External Trigger Inputs Interface: 10/100 Ethernet with Software and browser-based GUIs. SDKs are also available.</p> <p>For more information about our DCS-103E, please visit the controller product page.</p>	
	<p>Pulsar 320E High Current Controller - Compatible with C5 Configuration PN: Pulsar 320E</p> <p>The Pulsar 320E is a high-power, dual output, pulse-only controller geared for overdriving driving lights at very short flash durations with very high current.</p> <p>Output Power: 2500 W Max Pulsed / Output Output Current: 50 A Max Pulsed / Output I/Os: 2 External Trigger Inputs Interface: 10/100 Ethernet with Software GUI. SDKs are also available.</p> <p>For more information about our Pulsar 320E, please visit the controller product page.</p>	

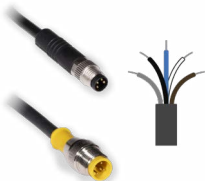
Electrical Information - Continued

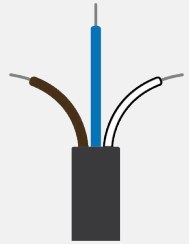
Controller Image	Controller Details	Connector Image
	<p>Inline Controller - Continuous Only - IC Configurations <i>PN: N/A</i></p> <p>The IC is an inline, cable-mounted continuous-only controller configured/wired directly for the ordered light head.</p> <p>Output Power: 25 W Max Continuous Output Current: 1.25 A Max Continuous I/O: 1 0-10 V Analog Dimming Input Interface: Direct Cable (flying leads or optional connector)</p> <p>For more information about our IC Controller please visit the controller product page.</p>	
	<p>Inline Controller - Strobe and Continuous - I3 & I3S Configurations <i>PN: N/A</i></p> <p>The I3 and I3S are inline, cable-mounted continuous and pulse (overdrive strobe) capable controllers configured/wired directly for the ordered light head. When operated in pulsed mode, the I3 is a default-on device on power up, whereas the I3S is default-off, requiring a trigger to illuminate.</p> <p>Output Power: 25 W Max Continuous, 125 W Max Pulsed Output Current: 1.25 A Max Continuous, 8 A Max Pulsed (Load Dependent) I/Os: 1 Gated Trigger Signal, 1 0-10 V Analog Dimming Input Interface: Direct Cable (flying leads or optional connector)</p> <p>For more information about our I3/I3S Controller, please visit the controller product page.</p>	
	<p>Inline Controller - Strobe and Continuous - I4 Configurations <i>PN: N/A</i></p> <p>The I4 is an inline, cable-mounted continuous and pulse (overdrive strobe) capable controller configured/wired directly for the ordered light head. The I4 can either be operated with a PNP or NPN trigger signal.</p> <p>Output Power: 50 W Max Continuous, 150 W Max Pulsed Output Current: 2.1 A Max Continuous, 8 A Max Pulsed (Load Dependent) I/Os: 1 Gated Trigger Signal, 1 0-10 V Analog Dimming Input Interface: Direct Cable (flying leads or optional connector)</p> <p>For more information about our IC Controller please visit the controller product page.</p>	
	<p>24V Driver - Continuous Only - 24 Configurations <i>PN: N/A</i></p> <p>24V option allows lights to operate continuous output with 24V connection and no additional controllers.</p> <p>Modes: Continuous, can be wired to some 3rd party controllers or external relays for gated operation Interface: Direct cable (flying leads or connector options)</p>	

Electrical Information - Continued

Inline Control Option Wiring Information

Standard Flying Lead and Optional M12 Connector Pinout Functions

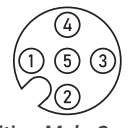
Pin (M12)	Wire Color	24V Functions	IC Functions	I3/I3S Functions	I4 Functions	M12 Pinout
1	BROWN	24V DC	24V DC	24V DC	24 V DC	 5-Position Male Connector
2	WHITE	N/A	0-10V Analog Control	Reserved	NPN/Active Low Trigger	
3	BLUE	DC GND	DC GND	DC GND	DC GND	
4	BLACK	N/A	Gate Low	PNP/Active High Trigger	PNP/Active High Trigger	
5	GRAY	N/A	N/A	0-10V Analog Control	0-10 V Analog Dimming	

The functions above are only applicable when ordering an 24, IC, I3, I3s, or I4 power configuration with our without an M12 connector. For more wiring information pertaining to strobing and dimming functionality, please download the controller manuals and datasheets.

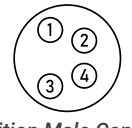

Optional M8 Connector Pinout Functions

Pin (M8)	Wire Color	24V Functions	IC Functions	I3/I3S Functions	I4 Functions	M8 Pinout
1	BROWN	24V DC	24V DC	24V DC	24 V DC	 4-Position Male Connector
2	WHITE	N/A	0-10V Analog Control	Reserved	Active Low Trigger	
3	BLUE	DC GND	DC GND	DC GND	DC GND	
4	BLACK	N/A	Gate Low	Active High Trigger	Active High Trigger	





The functions above are only applicable when ordering an 24, IC, I3, I3s, or I4 power configuration with our without an M8 connector. For more wiring information pertaining to strobing and dimming functionality, please download the controller manuals and datasheets.

Accessories

Advanced Illumination offers a variety of accessories designed to pair with our lighting and control products. Below you will find a table of accessories which are compatible with many configurations of the BX and CX Series.

Category	Accessory Image	Accessory Detail
Power Supply		<p>24 Volt DC Power Supply PN: PS24-TL</p> <p>This convenient power source is a universal AC input switching power supply with a regulated output DC current. The power supply comes with an LED Power Indicator, tinned leads marked Positive (+) and Negative (-) and 2 WAGO connectors for simplified assembly.</p> <p>For more information about our 24 Volt DC Power Supply, please visit this webpage.</p>
Dimmer		<p>Manual Dimming Accessory for the IC, I3 and I3s PN: DCS-MP</p> <p>The DCS-MP is a 30-position potentiometer, detented for precision level control and provides repeatable dimming with cable inline controllers. Features include DIN-rail mountable, a flip up cover to prevent accidental adjustments, spring clamp wiring terminal for flying leads or an M12 connector for use with the IC or I3/I3S Inline Controllers.</p> <p>For more information about our Manual Dimming Accessory please visit this webpage.</p>
Dimmer		<p>Manual Dimming Accessory for the IC PN: MP-ICS</p> <p>The MP-ICS is a dimmer which is designed for use on lights with the IC Inline Controller. This unit provides for 0 – 100% intensity control. It is NOT COMPATIBLE with LLI37, BLI38, LLI67, and BLI68 "IC" Lights or lights built with the "24v controller" option.</p> <p>For more information about our Manual Dimming Accessory, please visit this webpage.</p>

Electrical Information - Continued

Category	Accessory Image	Accessory Detail
Extension Cable		<p>DCS-100E/103E Extension Cable, Single Light Power Cable - C1 Configuration PN: LC-XX-S</p> <p>This extension cable was designed for applications requiring power cables longer than the standard 2 meters provided with Ai lights. This single light cable features a single male and single female 7 pin locking connector (C1) and can be purchased in 3 - 15-meter lengths.</p> <p>For more information about our DCS-100E/103E Extension Cable, Single Output, please visit this webpage.</p>
Extension Cable		<p>DCS-100E/103E Extension Cable, Dual Light Power Cable - C1 Configuration PN: LC-XX-Y</p> <p>This extension cable was designed for applications requiring two identical lights to be powered through a single controller. These Y cables feature a single male and dual female 7 pin locking connectors (C1) and can be purchased in 3 - 15-meter lengths. See attached spec sheet for compatible light configuration.</p> <p>For more information about our DCS-100E/103E Extension Cable, Split Output, please visit this webpage.</p>
Extension Cable		<p>Pulsar 320E Extension Cable - C5 Configuration PN: LC-XX-S-C5</p> <p>This extension cable was designed for applications requiring power cables longer than the standard 2 meters provided with Ai lights. This single light cable features a single male and single female Pulsar 320 connector (C5) and can be purchased in 3 - 15 meter lengths.</p> <p>For more information about our Pulsar 320E Extension Cable, please visit this webpage.</p>
Adaptor Cable		<p>Cognex Gen2 Inline Controller Adaptor Cable PN: AD-I3-CGX2</p> <p>This cable adaptor is for connecting I3/I3S configured lights with Cognex Gen2 Cameras, and comes with a male to female M12 connectors.</p> <p>For more information about our Cognex Gen2 Inline Controller Adaptor Cable, please visit this webpage.</p>
Filters		<p>Camera Lens Band Pass Filters PN: BPXXX-YYY</p> <p>Eliminating all but a narrow band of light (+/- 40nm) centered on the specified wavelength, band pass filters are used to enhance colors, or to stop unwanted ambient light from reaching the camera. Filtering can replace existing shrouds, simplifying the physical set up of an inspection site. Ai offers 635nm and 660nm band pass filters to fit several different lens sizes.</p> <p>For more information about our Camera Lens Band Pass Filters, please visit this webpage.</p>

Additional Information

Warranty

Every Advanced illumination, Inc. (Ai) product is thoroughly inspected and tested before leaving the factory. Products are warranted to be free of defects in workmanship and materials for a period of FIVE YEARS from the original date of purchase. Should a defect develop during this period, customers may return the complete product, freight prepaid, to one of Ai's distributors or to the Ai factory. All product warranty returns require a Return Merchandise Authorization (RMA) number which is obtained from Customer Service. The RMA number must be clearly marked on the outside of the package. Ai will inspect the unit, and if a defect is found will, at our option, repair or replace the product without charge. Ai disclaims liability for any implied warranties, including implied warranties of "merchantability" and "fitness for a specific purpose." For products under warranty that have since been discontinued, Ai will make an effort to replace with equivalent parts; for circumstances that do not allow for equivalent replacement, Ai reserves the right to repair or replace these products with an updated version. Ai cannot be held responsible for the unauthorized or inappropriate use of its products. Any unauthorized repair or modifications will result in a voided warranty. No Liability for Consequential Damages: In no event shall Ai be liable for any consequential, special, incidental, or indirect damages of any kind arising from the sale or use of the products.

Compliance

Our lighting products are designed and tested to meet CE, RoHS, and IEC standards. As a global ISO 9001 certified company, we understand the importance of compliance and perform accelerated testing on every product before shipment. For more information on our compliance standards, please see our compliance documentation here: <https://www.advancedillumination.com/services/compliance-statements/>

Electromagnetic Compatibility

This product was tested and complies with the regulatory requirements and limits for electromagnetic compatibility (EMC) as stated in the product specifications. These requirements and limits are designed to provide reasonable protection against harmful interference only when the product is operated in its intended industrial electromagnetic environment. To minimize the potential for electromagnetic interference or unacceptable performance degradation, install and use this product in strict accordance with the instructions in the product documentation.

Customer Service

For information on existing orders, or to make an order adjustment, contact us Monday through Friday 8:00 am to 5:00 pm ET or send an email to orders@advancedillumination.com.

Company Information

Advanced Illumination
440 State Garage Road, Rochester, VT 05767
Phone: +1 (802) 767 3830
Fax: +1 (802) 767 2636
Email: info@advancedillumination.com
Web: advancedillumination.com
© 2023 Advanced illumination Inc. All rights reserved