

# SOPHIA<sup>®</sup> 2048B

LARGE-FORMAT CCD CAMERAS

## Datasheet

ULTRA-LOW-LIGHT, LOW-NOISE UV / VIS CAMERAS



# Breakthrough High-Performance CCD Cameras



SOPHIA 2048B cameras are designed from the ground up for the most demanding low-light applications, such as astronomy, *in vivo* imaging, and semiconductor failure analysis:

- ▶ Back-illuminated CCD sensors with >95% peak QE
- ▶ 2048 x 2048 resolution with 13.5 and 15 micron pixels
- ▶ High frame rates with up to 4-port readout
- ▶ Cooling down to -90°C using liquid or air

## Applications include:

Semiconductor Failure Analysis | Astronomy | Photometry | Laser Beam Profiling | Luminescence and Fluorescence Imaging | *In Vivo* Imaging

Princeton Instruments SOPHIA 2048B cameras deliver speed, resolution, and sensitivity.

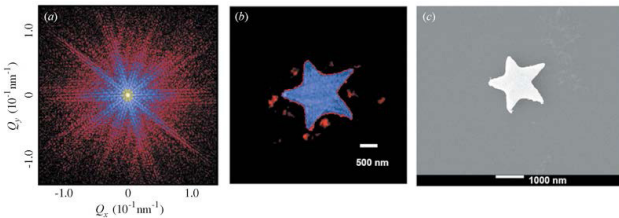

## Designed for low-light applications...

SOPHIA 2048B cameras offer optimum performance:

- ▶ Low read noise
- ▶ High QE (peak >95%)
- ▶ Wide dynamic range (16-bit readout)

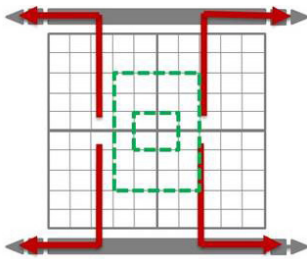

## When speed is paramount...

SOPHIA 2048B cameras have the newest readout electronics:

- ▶ Single-, dual-, and quad-port simultaneous readout
- ▶ Multiple ADC speeds (up to 16 MHz)
- ▶ Binning and ROI readout
- ▶ Custom readout modes for microsecond exposures

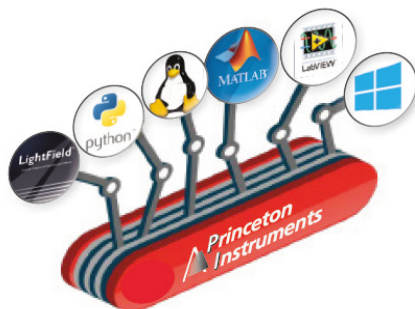

## We give you the most options!

Most imaging experiments need flexibility – and the SOPHIA 2048B is a perfect fit:

- ▶ Air or liquid cooling
- ▶ Microsoft® Windows® 10 or Linux® 64-bit operating system support
- ▶ Seamless integration of controls and data acquisition into MATLAB® (MathWorks), LabVIEW® (National Instruments), ASCOM, Maxim DL™ (Cyanogen Imaging), and Python®
- ▶ SDK / API compatible with Microsoft Windows and Linux

# Key Camera Features

The SOPHIA 2048B is available with a choice of two sensors:

**SOPHIA 2048B - 132**

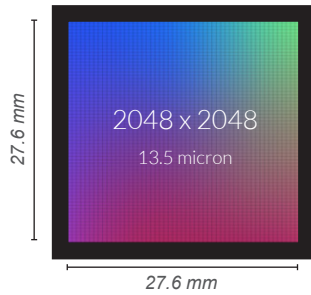

**SOPHIA 2048B - 152**

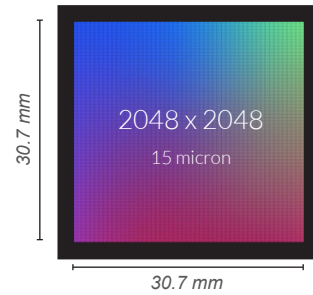

e2v CCD42-40: 2048 x 2048 resolution sensor with 13.5 micron pixels and up to 8 MHz readout (2 x 4 MHz)

e2v CCD230-42: 2048 x 2048 resolution sensor with 15 micron pixels and up to 16 MHz readout (4 x 4 MHz)

Proprietary 2-port and 4-port readout for low noise and high frame rates

Ultra-high-vacuum, all-metal seal design for deep cooling (ArcTec™) down to -90°C

Flexibility to use air, air+liquid, or liquid cooling

The latest UHV technology with all-metal construction and industry-standard CF vacuum interface

## The most comprehensive software support

Acclaimed LightField software for Microsoft Windows 10 (64 bit)

Seamless integration of controls and data acquisition into LabVIEW, MATLAB, ASCOM, Maxim DL, and Python

PICam software development kit (SDK) for Linux and Microsoft Windows

# Exceptional Reliability

Princeton Instruments has been designing high-performance scientific cameras for more than three decades:

- ▶ Hundreds of cameras being used at leading laboratories around the world
- ▶ Years of trouble-free operation a result of uncompromised engineering design and production
- ▶ Complete software ecosystem simplifies image acquisition and processing
- ▶ Continuous innovation to meet evolving requirements and applications

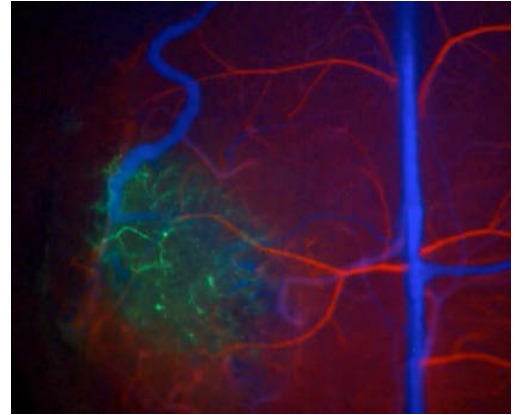

Princeton Instruments SOPHIA 2048B cameras are the most advanced large-format CCD cameras yet!



# SOPHIA 2048B - 132 Specifications

Feature	SOPHIA 2048B-132-VS-R	SOPHIA 2048B-132-VS-UV	SOPHIA 2048B-132	SOPHIA 2048BX-132
CCD image sensor	e2v CCD42-40; back illuminated; deep depleted; grade 1; NIMO	e2v CCD42-40; back illuminated; UV enhanced; grade 1; NIMO	e2v CCD42-40; back illuminated; grade 1; NIMO	Back illuminated eXcelon CCD; Highest sensitivity
Dark current @ -90°C (with ambient air @ +20°C)	0.0001 e-/p/s (typical)			
Quantum efficiency	See QE curves on next page			
CCD format	2048 x 2048 imaging pixels; 13.5 x 13.5 μm pixels; 100% fill factor			
Imaging area	27.6 x 27.6 mm (optically centered)			
Deepest cooling temperature	< -90°C (typical) with liquid chiller; < -90°C (typical) with air			
Thermostating precision	±0.05°C			
Cooling method	Thermoelectric air or liquid cooling (liquid chiller required)			
Full well	Single pixel: 100 ke- (typical), 80 ke- (minimum);			
ADC speed/16 bits	8 MHz, 2 MHz, and 200 kHz			
System read noise per port @ 100 kHz @ 1 MHz @ 4 MHz	3.5 e- rms (typical) 7 e- rms (typical) 19 e- rms (typical)			
Vertical shift speed	24 μsec/row (programmable)			
Nonlinearity	<1% @ 100 kHz			
Software-selectable gains	1, 2, 4 e-/ADU (low-noise input, typical)			
Data interface	USB 3.0 (5 m interface cable provided); Optional fiberoptic interface available for remote operation			
I/O signals	Two MCX connectors for programmable frame readout, shutter, trigger in			
Operating environment	+5°C to +30°C non-condensing			
Bake-out temperature	70°C (maximum)			
Certification	CE			
Camera head dimensions (L x W x H)	251.6 mm (9.91") x 129 mm (5.08") x 142.8 mm (5.62")			
Camera head weight	6.5 kg (14.3 lbs)			

*Specifications are subject to change.*

# SOPHIA 2048B - 132 Quantum Efficiency Curves

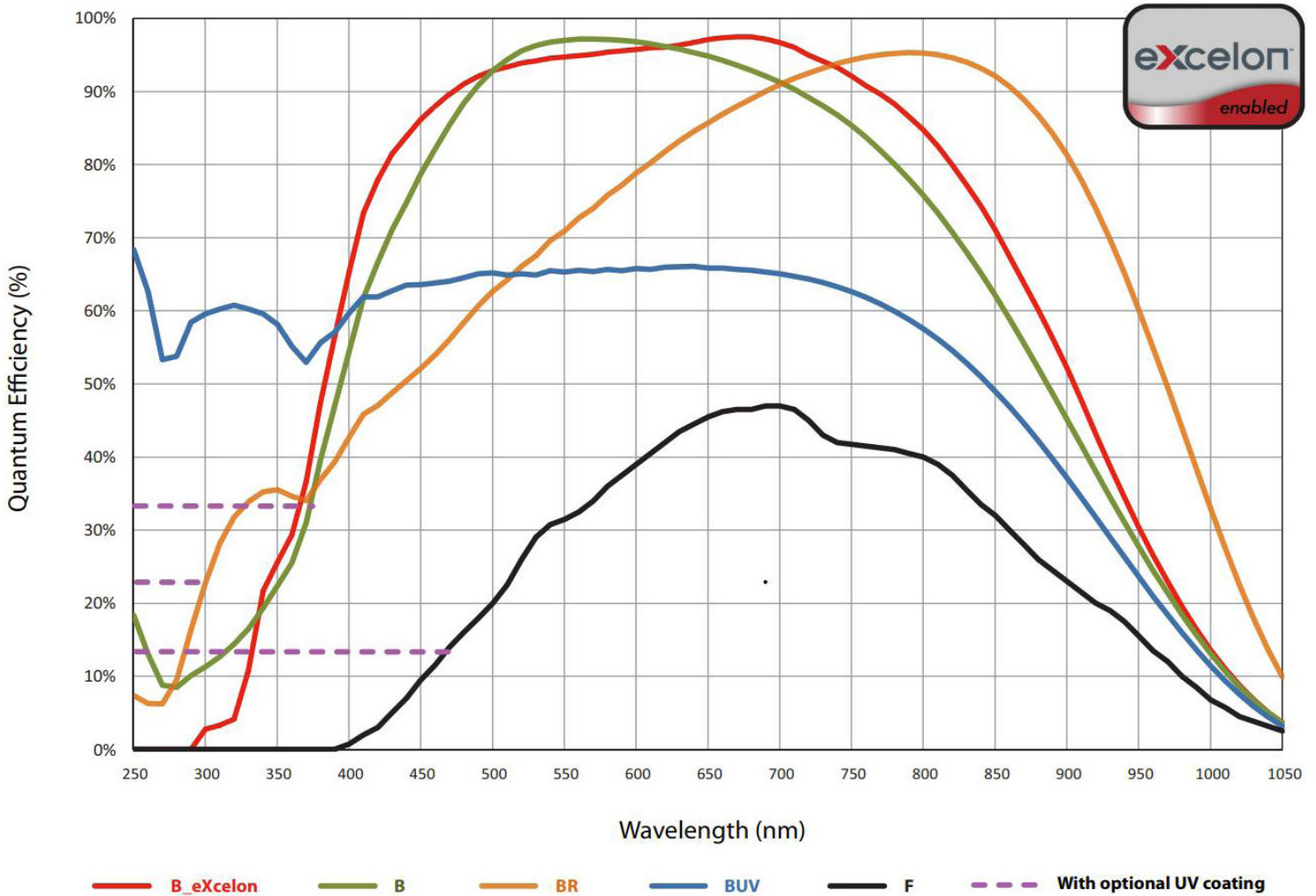

## Frame Rates

SOPHIA 2048B - 132

Binning	8 MHz	2 MHz	200 kHz
1 x 1	1.35	0.43	0.05
2 x 2	2.82	1.34	0.18
4 x 4	3.76	2.82	0.65
8 x 8	4.30	3.76	1.82

# SOPHIA 2048B - 152 Specifications

Feature	2048B-152-VS-X	2048B-152-VS-MB
CCD image sensor	Back-illuminated eXcelon CCD. Highest sensitivity in the visible region. High sensitivity in the NIR. Extremely low etaloning. 100x lower dark charge than deep-depleted sensors.	Back-illuminated CCD. Highest sensitivity in the visible region. Basic midband (MB) AR coating.
	Princeton Instruments' proprietary CCD; grade 1; AIMO	e2v CCD230-42; grade 1; AIMO
Dark current @ -90°C (with ambient air @ +20°C)	0.00025 e-/p/s (typical)	
CCD coating	Optional UV coating	
Quantum efficiency	See QE curves on next page	
CCD format	2048 x 2048 imaging pixels; 15.0 x 15.0 µm pixels; 100% fill factor	
Imaging area	30.7 x 30.7 mm (optically centered)	
Lens mount	F-mount with integral 45 mm shutter	
Deepest cooling temperature	< -90°C (typical) with liquid chiller; < -90°C (typical) with air	
Thermostating precision	±0.05°C	
Cooling method	Thermoelectric air or liquid cooling (liquid chiller required)	
Full well	Single pixel: 150 ke- (typical)	
ADC speed/16 bits	16 MHz, 4 MHz, and 400 kHz	
System read noise per port @ 100 kHz @ 1 MHz @ 4 MHz	3.6 e- rms (typical) 8.5 e- rms (typical) 22 e- rms (typical)	
Vertical shift speed	24 µsec/row (programmable)	
Nonlinearity	<1% @ 100 kHz	
Software-selectable gains	1, 2, 4 e-/ADU (low-noise input, typical)	
Data interface	USB 3.0 (5 m interface cable provided); Optional fiberoptic interface available for remote operation	
I/O signals	Two MCX connectors for programmable frame readout, shutter, trigger in	
Operating environment	+5°C to +30°C non-condensing	
Certification	CE	
Camera head dimensions (L x W x H)	251.6 mm (9.91") x 129 mm (5.08") x 142.8 mm (5.62")	
Camera head weight	6.5 kg (14.3 lbs)	

*Specifications are subject to change.*

# SOPHIA 2048B - 152 Quantum Efficiency Curves

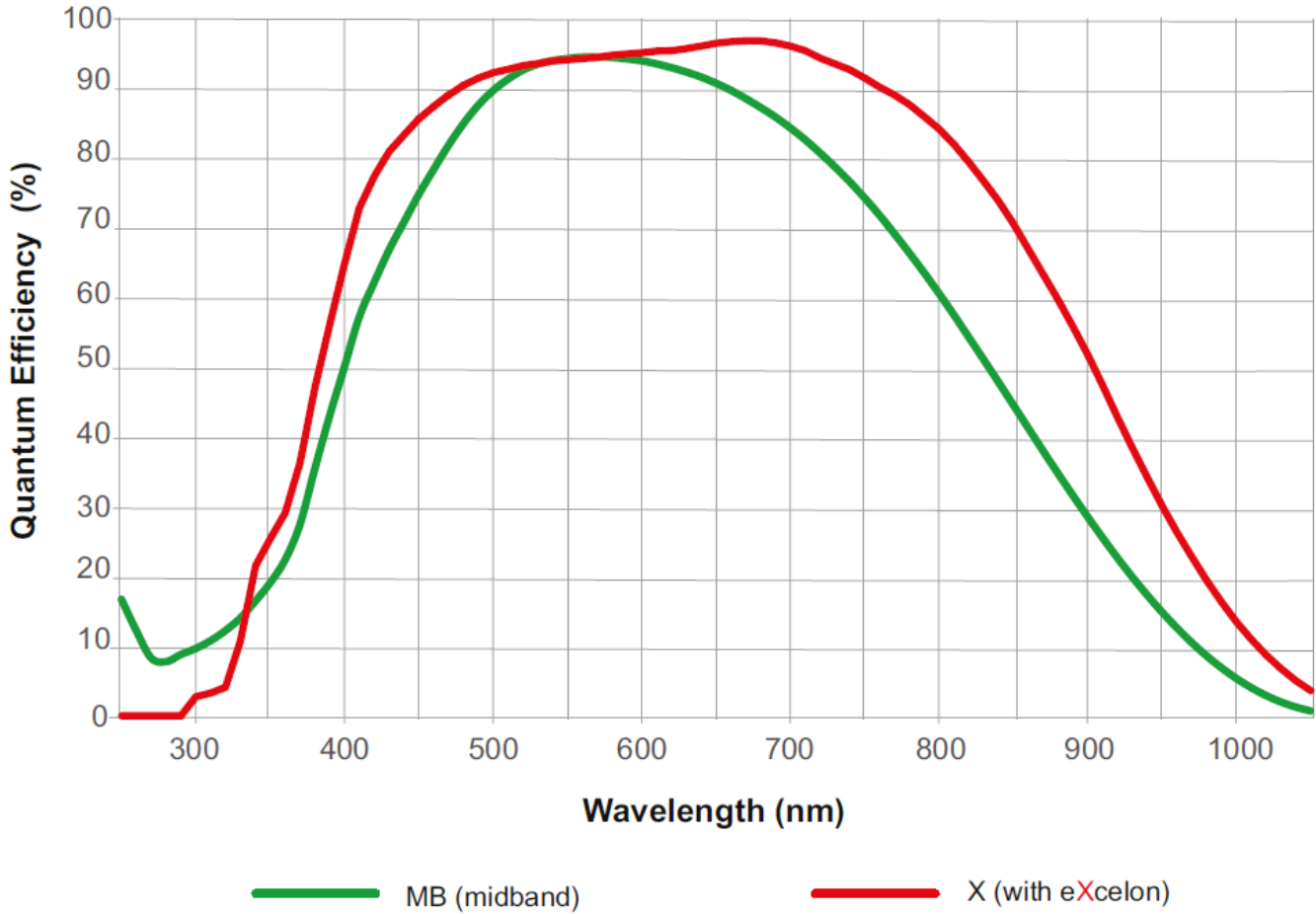

## Frame Rates

SOPHIA 2048B - 152

Binning	16 MHz	4 MHz	400 kHz
1 x 1	3.2	0.9	0.09
2 x 2	7.4	2.9	0.33
4 x 4	14.3	7.7	1.05
8 x 8	22.2	15.4	2.9



SOPHIA 2048B - 132  
 SOPHIA 2048B - 152

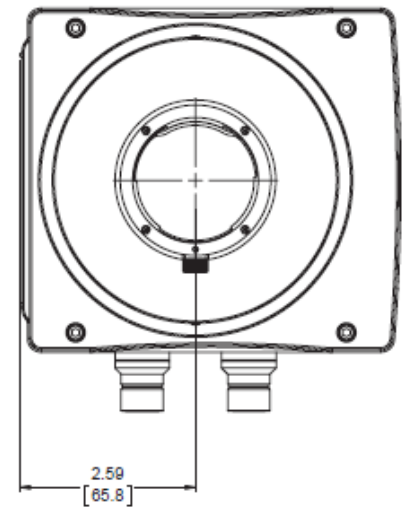
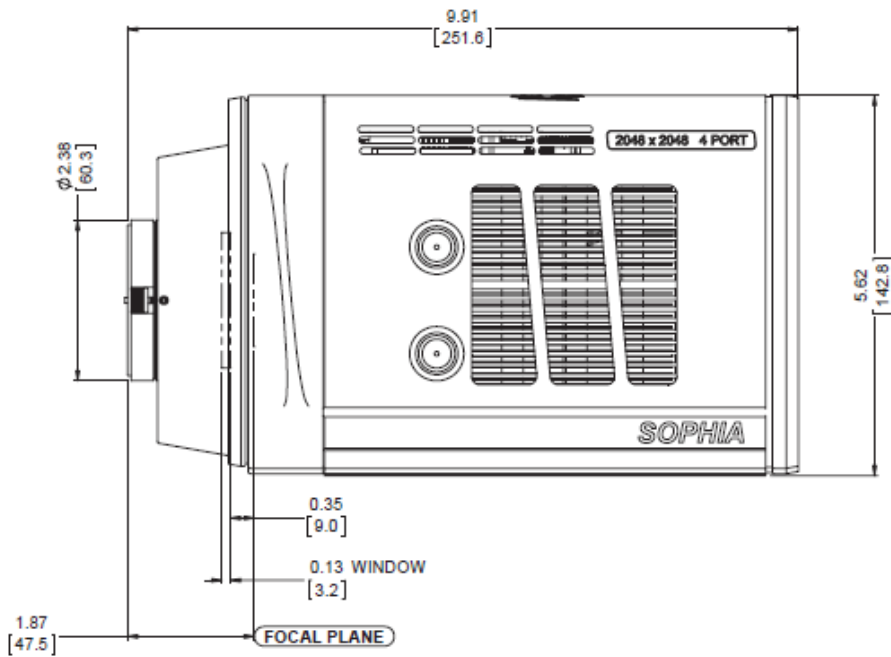
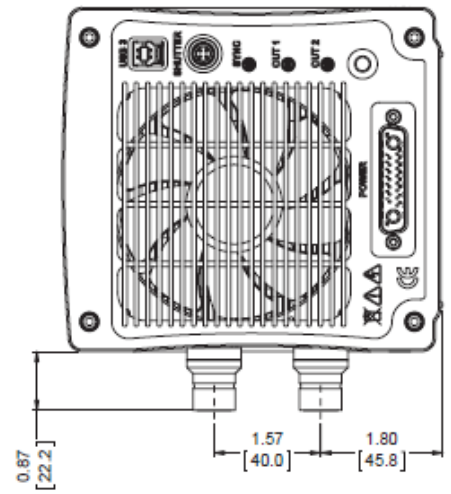
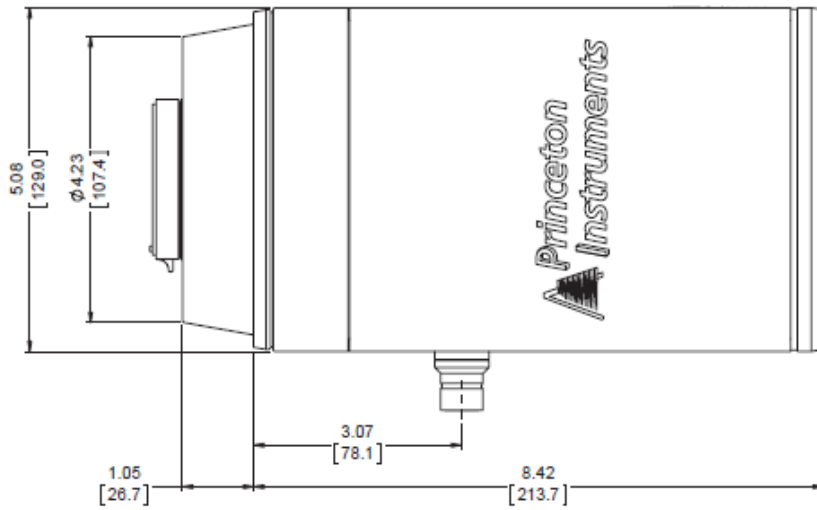

Weight: 6.5 kg (14.3 lbs)

# eXcelon® Advantages

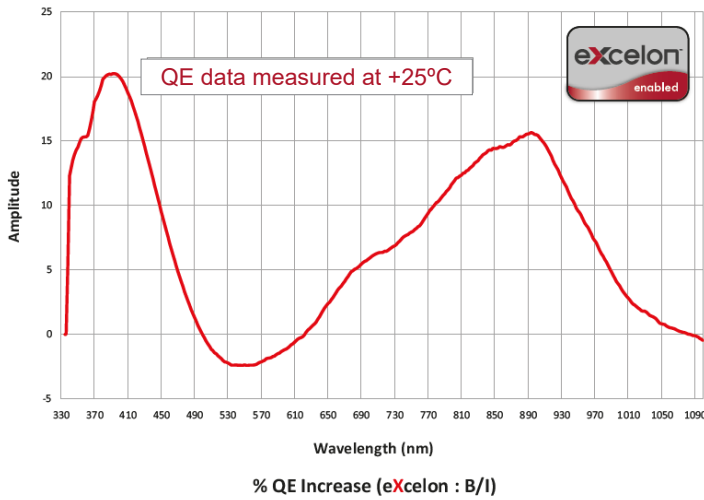

B\_eXcelon provides superior QE over the standard back-illuminated (“B/I”) version in the UV-NIR range.

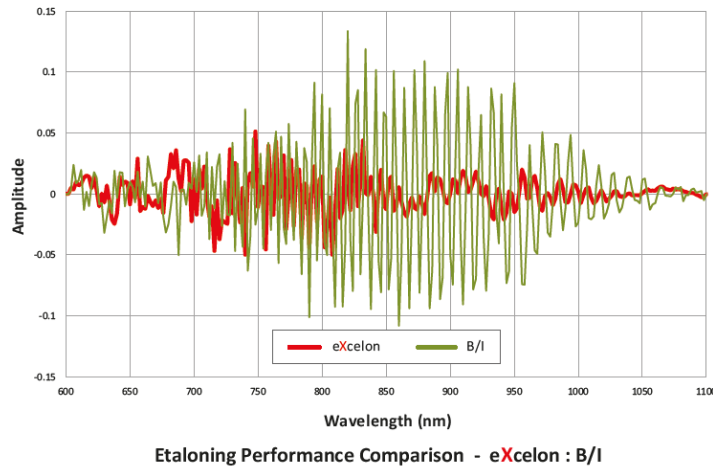

B\_eXcelon provides significantly lower etaloning (unwanted fringes) compared to standard back-illuminated (“B/I”) version.

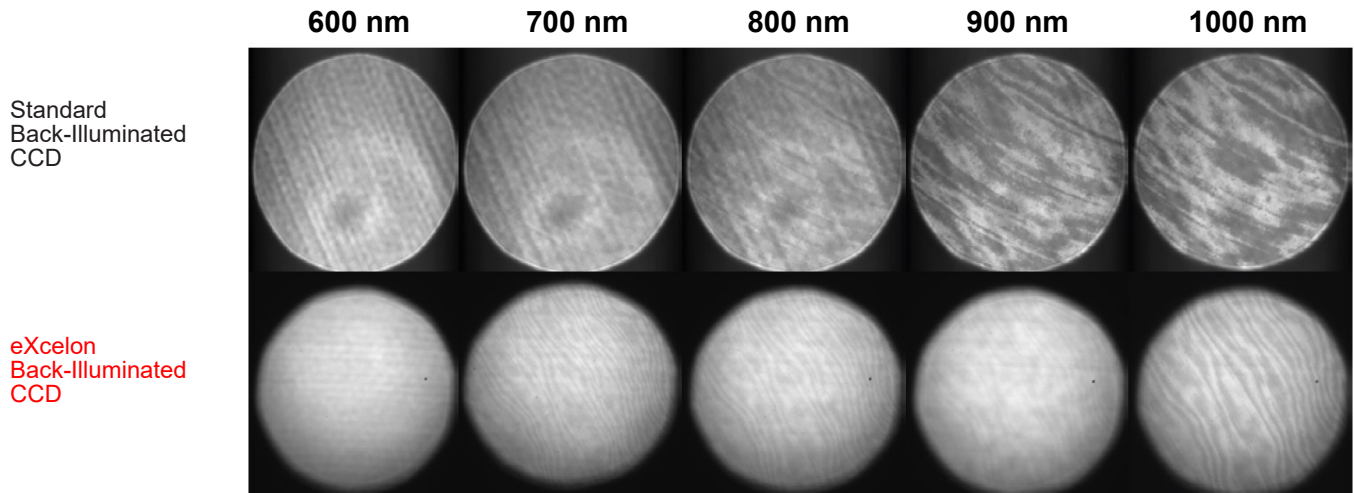

Data taken with white light source through a monochromator comparing etaloning performance of eXcelon vs. back-illuminated CCDs.

# LightField<sup>®</sup> Software

## The Future of Scientific Imaging and Spectroscopy Software

The combination of LightField and the SOPHIA 2048B provides researchers with the most advanced and reliable toolset for experimental setup, data acquisition, and post processing:

- ▶ Powerful 64-bit software package includes Microsoft Windows 10 support
- ▶ Complete control of Princeton Instruments cameras and spectrometers
- ▶ Dependable data integrity via automatic saving to disk, time stamping, and retention of both raw and corrected data
- ▶ Full experimental details and system settings are archived and can be reloaded for future experiments ensuring maximum reproducibility
- ▶ For light-sensitive experiments, the user interface offers “low light” and “no light” modes during data acquisition
- ▶ LightField works seamlessly in multi-user facilities, remembering each user’s hardware and software configurations
- ▶ Simple math functions and complex transforms can be applied to live or stored data, includes an easy-to-use editor to create your own formulas
- ▶ Integrated LabVIEW (National Instruments), MATLAB (MathWorks), ASCOM, Maxim DL (Cyanogen Imaging), and Python support
- ▶ Exports to your favorite file formats, including TIFF, FITS, ASCII, AVI, IGOR, and Origin
- ▶ Demo camera mode allows the user to view all of the settings and parameters associated with any camera without physically connecting the camera
- ▶ Live data processing operations provide real-time evaluation of incoming data to optimize experimental parameters

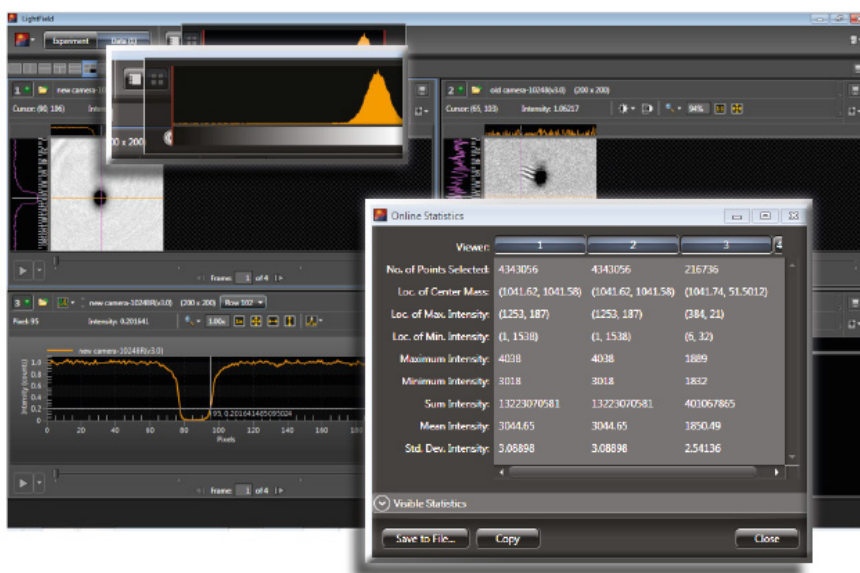

# What is in the box?

SOPHIA 2048B cameras can be provided in custom configurations to suit your experiment. Please contact your local Princeton Instruments representative. The most common configurations are listed below:

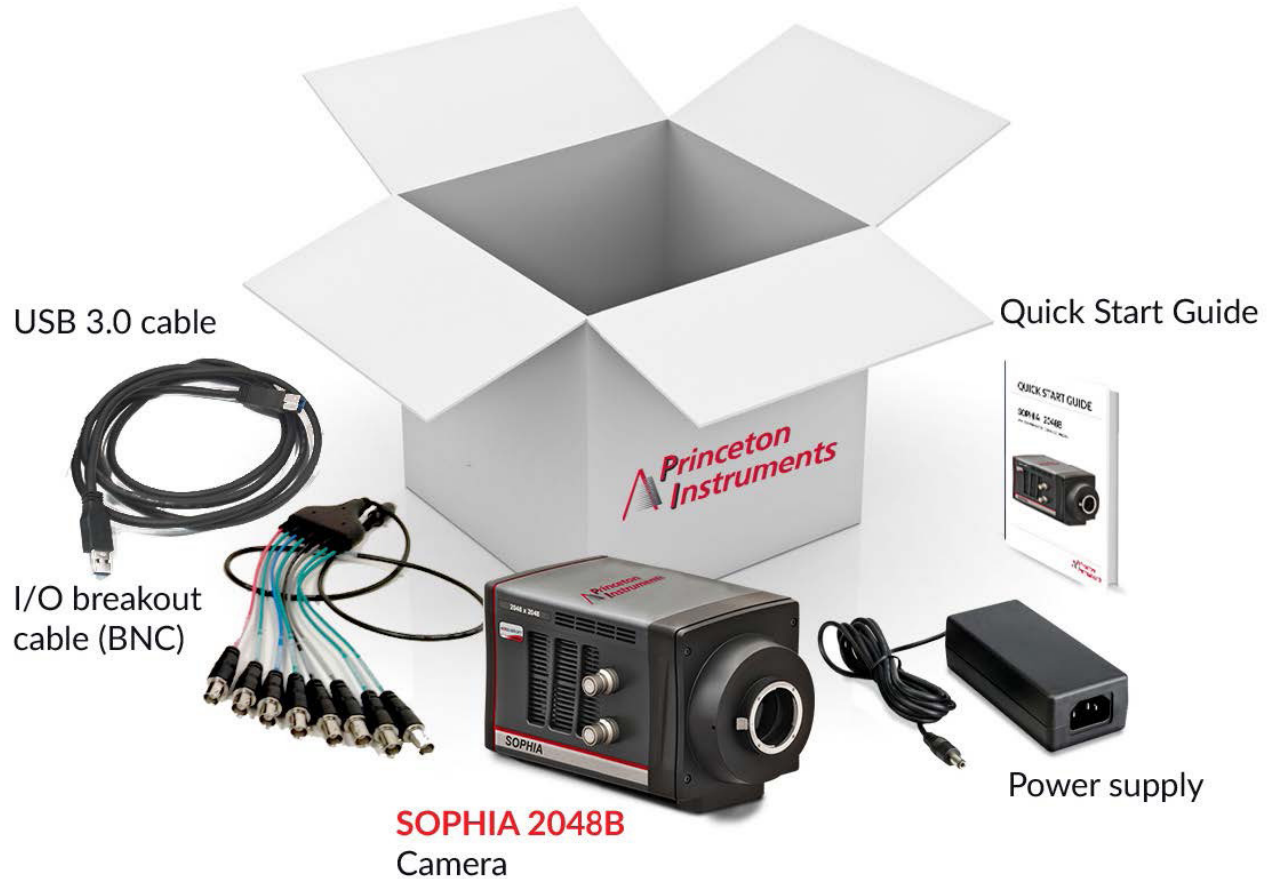

## Optional accessories:

- LightField software
- PICam SDK/API for Linux and Microsoft Windows (provided for free)
- Liquid chiller
- Fiberoptic data extension cable for remote operation from up to 30 m

## Other high-performance cameras from Princeton Instruments:

- **SOPHIA 4096B** – Ultra-large 4k x 4k format, low-noise CCD cameras
- **PIXIS** – Small-format 1k x 1k and 2k x 2k CCD cameras
- **KURO™** – Large-format, high-speed, back-illuminated scientific CMOS cameras

# SOPHIA 2048B

Large-Format, Low-Light CCD Cameras



#### Image Credits

Front/back cover:

Pleiades image courtesy of Rozhen National Astronomical Observatory, Bulgaria.

Page 2:

Yu *et al.*, "Coherent X-ray scattering beamline at port 9C of Pohang Light Source II," *J. Synchrotron Rad.* **21**, 264-267 (2014). doi: 10.1107/S1600577513025629

Page 4:

Top: SWIR angiography image courtesy of Dr. Oliver T. Bruns and Dr. Thomas S. Bischof, Bawendi Lab, MIT, Cambridge, MA, USA. Center: Gravity waves & Milky Way image courtesy of Dr. Young-In Won, Korea Polar Research Institute. Bottom: Pleiades image courtesy of Rozhen National Astronomical Observatory, Bulgaria.

revA5

Copyright © 2018 Teledyne Princeton Instruments, Inc. All rights reserved. ArcTec and KURO are trademarks and SOPHIA, eXcelon, and LightField are registered trademarks of Princeton Instruments, Inc. Microsoft and Windows are registered trademarks of Microsoft Corporation in the United States and other countries. Linux is the registered trademark of Linus Torvalds in the U.S. and other countries. Python is a registered trademark of the Python Software Foundation. All other brand and product names are the trademarks or registered trademarks of their respective owners and manufacturers.

Contact your local Princeton Instruments representative for additional information.

#### Princeton Instruments - USA

Tel: +1 609.587.9797  
pi.info@teledyne.com

#### China

Tel: +86 157 2153 5343  
pi.info.china@teledyne.com

#### France

Tel: +33 (0)1 70 38 19 00  
EVR@teledyne.com

#### Germany

Tel: + 49 (0) 89-660 779 30  
pi.germany@teledyne.com

#### Japan

Tel: JapanTel: +81.3.6709.0631  
PI.Nippon@teledyne.com

#### United Kingdom

Tel: +44 (0) 7810 835 719  
pi.info@teledyne.com