

# Lt Camera Series

## Compact, Lightweight USB3 Cameras

Compact and light-weight USB 3 cameras that provide both monochrome and vivid color images for the most demanding environments.

Teledyne Lumenera's Lt Camera Series digital cameras are built for rugged 24/7 use. Based on the latest advanced Starvis™ and Pregius™ CMOS sensors from Sony® capturing excellent quality images. Using the fully locking USB 3.1 Gen 1 cabling, the Teledyne Lumenera Lt Camera Series offers a variety of high performance models for many applications.

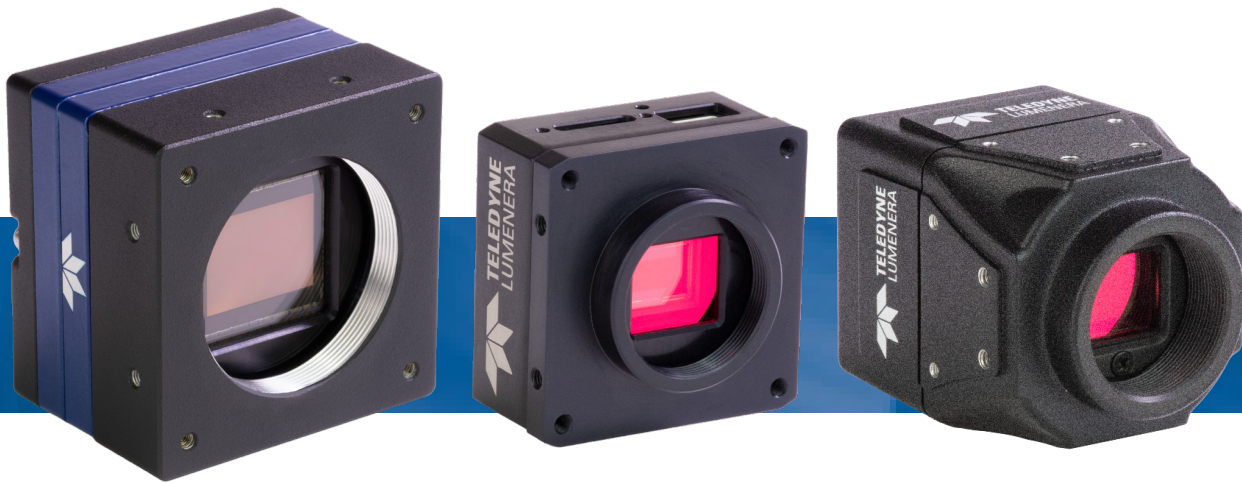

### Key Features

Wide selection of advanced Sony Global shutter and Rolling shutter CMOS sensors to meet the diverse requirements of today's industrial imaging applications.

### Reliability

Robust enclosure and ease of integration with USB 3.1 Gen 1 plug-and-play interface and fanless body, small footprint and lower power requirements



### Applications

Ready to meet the challenges of embedded system applications such as aerial imaging, intelligent traffic systems (ITS), robotic inspection, and life sciences.

### Compatibility













Flexible, proven 32 and 64-bit operating system compatibility for, Windows, Linux, Linux for embedded system platforms, and single board computers (SBCs).

Lt CAMERA SERIES SPECIFICATIONS

	Active Resolution	Sensor Model	Frame Rate (Burst Mode)	Pixel Size	Dynamic Range	Max. Image Circle	Part Number	Lens Mount Option
 <b>Lt-C1610</b>	1608 x 1104	Sony IMX432 (1.7M)	96 fps	9.00 µm	72.1 dB	1.1" Optical Format	LT-UC11-C1610IF	C-mount STD With IR cut-off filter
							LT-UC11-C1611IF	CS-mount STD With IR cut-off filter
 <b>Lt-M1610</b>	1608 x 1104	Sony IMX432 (1.7M)	96fps	9.00 µm	72.1 dB	1.1" Optical Format	LT-UM11-M1610	C-mount STD
							LT-UM11-M1611	CS-mount STD
 <b>Lt-C1630</b>	1632 x 1248	Sony IMX430 (2.0M)	86 fps	4.50 µm	73 dB	1/1.7" Optical Format	LT-UC11-C1630IF	C-mount STD With IR cut-off filter
							LT-UC11-C1631IF	CS-mount STD With IR cut-off filter
 <b>Lt-M1630</b>	1632 x 1248	Sony IMX430 (2.0M)	86 fps	4.50 µm	73 dB	1/1.7" Optical Format	LT-UM11-M1630	C-mount STD
							LT-UM11-M1631	CS-mount STD
 <b>Lt-C1900</b>	1944 x 1096	Sony IMX327 (2.1M) RS*	60 fps	2.90 µm	72.8 dB	1/2.8" Optical Format	LT-UC10-C1900IF	C-mount STD With IR cut-off filter
							LT-UC10-C1901IF	CS-mount STD With IR cut-off filter
 <b>Lt-C1950</b>	1936 x 1216	Sony IMX392 (2.3M)	162 fps	3.45 µm	73.27 dB	1/2.3" Optical Format	LT-UC10-C1950IF	C-mount STD With IR cut-off filter
							LT-UC10-C1951IF	CS-mount STD With IR cut-off filter
 <b>Lt-M1950</b>	1936 x 1216	Sony IMX392 (2.3M)	162 fps	3.45 µm	73.27 dB	1/2.3" Optical Format	LT-UM10-M1950	C-mount STD
							LT-UM10-M1951	CS-mount STD
 <b>Lt-C2020</b>	2064 x 1544	Sony IMX265 (3.2M)	55 fps	3.45 µm	73.56 dB	1/1.8" Optical Format	LT-UC11-C2020IF	C-mount STD With IR cut-off filter
							LT-UC11-C2021IF	CS-mount STD With IR cut-off filter
 <b>Lt-M2020</b>	2064 x 1544	Sony IMX265 (3.2M)	55 fps	3.45 µm	73.56 dB	1/1.8" Optical Format	LT-UM11-M2020	C-mount STD
							LT-UM11-M2021	CS-mount STD
 <b>Lt-C2050</b>	2064 x 1544	Sony IMX252 (3.2M)	151 fps	3.45 µm	73 dB	1/1.8" Optical Format	LT-UC00-C2050	C-mount STD
							LT-UC00-C2050IF	C-mount STD with IR cut-off filter
 <b>Lt-M2050</b>	2064 x 1544	Sony IMX252 (3.2M)	151 fps	3.45 µm	73 dB	1/1.8" Optical Format	LT-UM00-M2050	C-mount STD
							LT-UM00-M2050CG	C-mount STD with clear glass
 <b>Lt-C2420</b>	2464 x 2056	Sony IMX264 (5.1M)	35 fps	3.45 µm	73.2 dB	2/3" Optical Format	LT-UC11-C2420IF	C-mount STD With IR cut-off filter
							LT-UC11-C2421IF	CS-mount STD With IR cut-off filter
 <b>Lt-M2420</b>	2464 x 2056	Sony IMX264 (5.1M)	35 fps	3.45 µm	73.2 dB	2/3" Optical Format	LT-UM11-M2420	C-mount STD
							LT-UM11-M2421	CS-mount STD
 <b>Lt-C2450</b>	2464 x 2056	Sony IMX250 (5.1M)	93 fps	3.45 µm	73 dB	2/3" Optical Format	LT-UC00-C2450	C-mount STD
							LT-UC00-C2450IF	C-mount STD with IR cut-off filter
 <b>Lt-M2450</b>	2464 x 2056	Sony IMX250 (5.1M)	93 fps	3.45 µm	73 dB	2/3" Optical Format	LT-UM00-M2450	C-mount STD
							LT-UM00-M2450CG	C-mount STD with clear glass
 <b>Lt-M2470</b>	2472 x 2064	Sony IMX547 (5.1M)	92 fps	2.74 µm	72 dB	1/1.8" Optical Format	LT-UM11-M2470	C-mount STD
							LT-UM11-M2471	CS-mount STD
 <b>Lt-C3200</b>	3216 x 2208	Sony IMX428 (7.1M)	50 fps	4.50 µm	73 dB	1.1" Optical Format	LT-UC11-C3200IF	C-mount STD with IR cut-off filter
							LT-UC11-C3201IF	CS-mount STD with IR cut-off filter
 <b>Lt-M3200</b>	3216 x 2208	Sony IMX428 (7.1M)	50 fps	4.50 µm	73 dB	1.1" Optical Format	LT-UM11-M3200	C-mount STD
							LT-UM11-M3201	CS-mount STD
 <b>Lt-C3840</b>	3840 x 2160	Sony IMX334 (8.3M) RS*	44 fps	2.00 µm	70.53 dB	1/1.8" Optical Format	LT-UC10-C3840IF	C-mount STD With IR cut-off filter
							LT-UC10-C3841IF	CS-mount STD With IR cut-off filter
 <b>Lt-M3840</b>	3840 x 2160	Sony IMX334 (8.3M) RS*	44 fps	2.00 µm	70.53 dB	1/1.8" Optical Format	LT-UM10-M3840	C-mount STD
							LT-UM10-M3841	CS-mount STD
 <b>Lt-C4030</b>	4112 x 2176	Sony IMX267 (8.9M)	31 fps	3.45 µm	73.27 dB	1" Optical Format	LT-UC11-C4030IF	C-mount STD With IR cut-off filter
							LT-UM11-M4030	C-mount STD
 <b>Lt-M4030</b>	4112 x 2176	Sony IMX267 (8.9M)	31 fps	3.45 µm	73.27 dB	1" Optical Format	LT-UM11-M4030	C-mount STD
							LT-UC00-C4060	C-mount STD
 <b>Lt-C4060</b>	4112 x 2176	Sony IMX255 (8.9M)	56 fps	3.45 µm	72.7 dB	1" Optical Format	LT-UC00-C4060IF	C-mount STD with IR cut-off filter
							LT-UM00-M4060	C-mount STD
 <b>Lt-M4060</b>	4112 x 2176	Sony IMX255 (8.9M)	56 fps	3.45 µm	72.7 dB	1" Optical Format	LT-UM00-M4060CG	C-mount STD with clear glass

\* Rolling Shutter sensors

## Lt CAMERA SERIES SPECIFICATIONS

	Active Resolution	Sensor Model	Frame Rate Burst Mode	Pixel Size	Dynamic Range	Max. Image Circle	Part Number	Lens Mount Option
 <b>Lt-C4020</b>	4112 x 3008	Sony IMX304 (12M)	22 fps	3.45 µm	73.22 dB	1.1" Optical Format	LT-UC11-C4020IF	C-mount STD With IR cut-off filter
 <b>Lt-M4020</b>	4112 x 3008	Sony IMX304 (12M)	22 fps	3.45 µm	73.22 dB	1.1" Optical Format	LT-UM11-M4020	C-mount STD
 <b>Lt-C4040</b>	4112 x 3008	Sony IMX253 (12M)	40 fps	3.45 µm	74 dB	1.1" Optical Format	LT-UC00-C4040	C-mount STD
							LT-UC00-C4040IF	C-mount STD with IR cut-off filter
 <b>Lt-M4040</b>	4112 x 3008	Sony IMX253 (12M)	40 fps	3.45 µm	74 dB	1.1" Optical Format	LT-UM00-M4040	C-mount STD
							LT-UM00-M4040CG	C-mount STD with clear glass
 <b>Lt-C5470</b>	5472 x 3084	Sony IMX387 (16.9M)	32 fps	3.45 µm	73 dB	4/3" Optical Format	LT-UC20-C5475	M42-mount
 <b>Lt-M5470</b>	5472 x 3084	Sony IMX387 (16.9M)	32 fps	3.45 µm	73 dB	4/3" Optical Format	LT-UM20-M5475	M42-mount
 <b>Lt-C4430</b>	4432 x 4436	Sony IMX367 (19.7M)	28 fps	3.45 µm	73 dB	4/3" Optical Format	LT-UC20-C4435	M42-mount
 <b>Lt-M4430</b>	4432 x 4436	Sony IMX367 (19.7M)	28 fps	3.45 µm	73 dB	4/3" Optical Format	LT-UM20-M4435	M42-mount
 <b>Lt-C5500</b>	5472 x 3648	Sony IMX183 (20M) RS*	19 fps	2.4 µm	73 dB	1" Optical Format	LT-UC10-C5500IF	C-mount STD with IR cut-off filter
 <b>Lt-M5500</b>	5472 x 3648	Sony IMX183 (20M) RS*	19 fps	2.4 µm	73 dB	1" Optical Format	LT-UM10-M5500	C-mount STD
 <b>Lt-M4510</b>	4512 x 4512	Sony IMX541 (20.4M)	26 fps	2.74 µm	72 dB	1.1" Optical Format	LT-UM11-M4510	C-mount STD C-mount STD C-mount STD
 <b>Lt-C6480</b>	6480 x 4860	Sony IMX342 (31M)	17 fps	3.45 µm	73 dB	APS-C Optical Format	LT-UC20-C6485	M42-mount
 <b>Lt-M6480</b>	6480 x 4860	Sony IMX342 (31M)	17 fps	3.45 µm	73 dB	APS-C Optical Format	LT-UM20-M6485	M42-mount

\* Rolling Shutter sensors

## Lt CAMERA SERIES FAMILY SPECIFICATIONS (COMMON TO ALL MODELS)

	Lt Camera Series (Standard) Applicable to p/n: LT-xx1x-xxxxx	Lt Camera Series (with P-IRIS) Applicable to p/n: LT-xx0x-xxxxx	Lt Camera Series (XL) Applicable to p/n: LT-xx2x-xxxxx
<b>Data Output Transfer</b>	USB3.1 (5 Gbit/s)		
<b>Exposure Control</b>	Manual and automatic control		
<b>I/O Ports</b>	Locking connector; includes trigger in, strobe out, and auxiliary power input		
<b>Image Buffers</b>	128 MB		256 MB
<b>Lens Mount</b>	Standard CS & C Mount available	Standard C Mount	M42 Mount
<b>Size (L x H x W)</b>	36.1 x 45 x 45 mm		61 x 44 x 44 mm 44 x 59 x 59 mm
<b>Mass</b>	88 g	140 g	263 g
<b>Operating Temp</b>	0 to 50 °C		
<b>Power Supply</b>	5 V via Power Over USB	5 V via Power Over USB, 1.5 A, power through auxiliary I/O connector	10 to 28 V on auxiliary I/O connector
<b>Power Dissipation</b>	2.3 W to 3.6 W	~4 W	8 W
<b>Data Connector</b>	USB3 Type micro-B (Locking Connector supported)		
<b>Power and I/O Connector</b>	JST# SM09B-NSHSS-TB (mating part :JST # NSHR-09V-S )	Hirose-8 male connector. P-iris 4 pin connector	10-pin connector (Samtec TFM-105-02-L-D-WT)
<b>Camera Specification</b>	USB 3.1 interface , USB3 Vision v1.0 compliant		
<b>Software Platform</b>	Teledyne Sopera LT 8.6 for Windows, Lumenera Camera Software Development Kit (LINUX) or 3rd Party GenICam compliant SDK		
<b>Software Compatibility</b>	Part number LT-Ux1x-xxxxx compatible with USB3 Vision compliant software. Part number LT-Lx1x-xxxxx compatible with LuCam software API.	Part number LT-Ux0x-xxxxx compatible with USB3 Vision compliant software. Part number LT-Lx0x-xxxxx compatible with LuCam software API.	Part number LT-Ux2x-xxxxx compatible with USB3 Vision compliant software and LuCam software API versions 6.9 and newer.

## RESPONSIVITY GRAPHS

### Lt-C1900

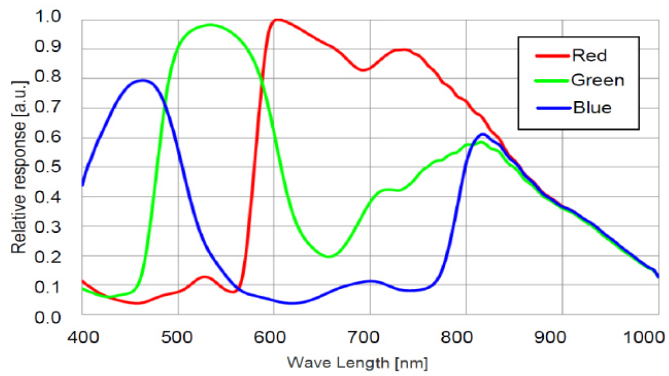

### Lt-C3840

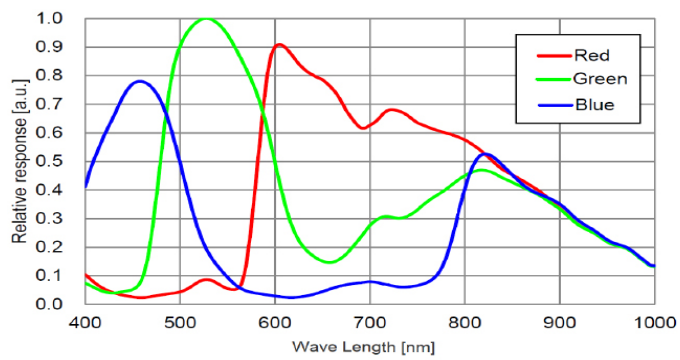

### Lt-C1950, C2020, C2050, C2420, C2450, C4030, C4060, C4020, C4040

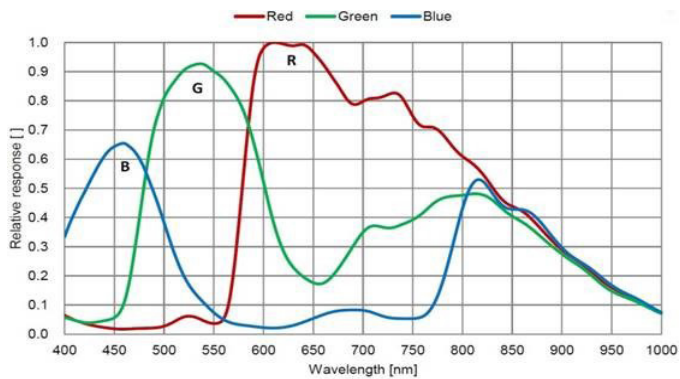

## RESPONSIVITY GRAPHS

### Lt-M2470, M4510

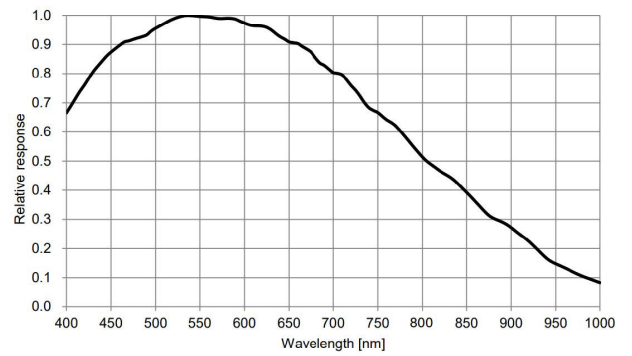

### Lt-M3840

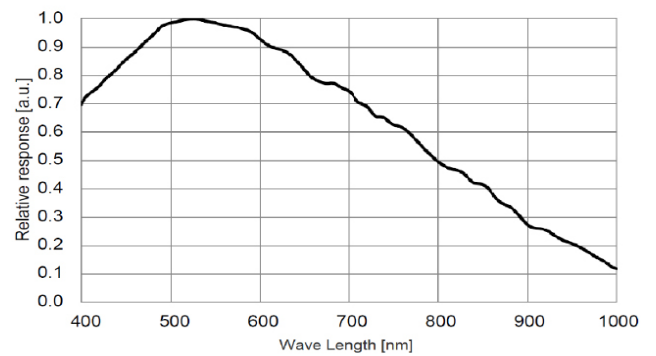

### Lt-M1950, M2020, M2050, M2420, M2450, M4030, M4060, M4020, M4040

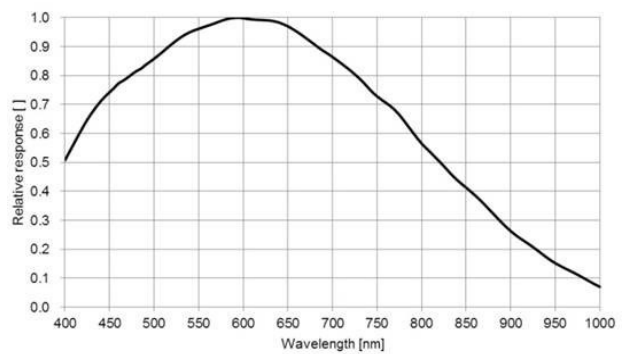

## RESPONSIVITY GRAPHS

**Lt-C1610, C1630, C3200**

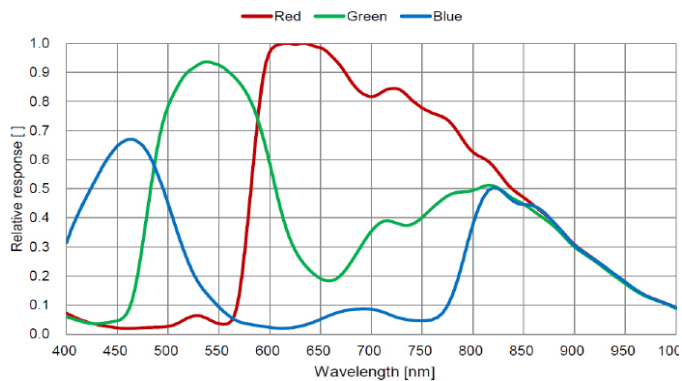

**Lt-M1610, M1630, M3200**

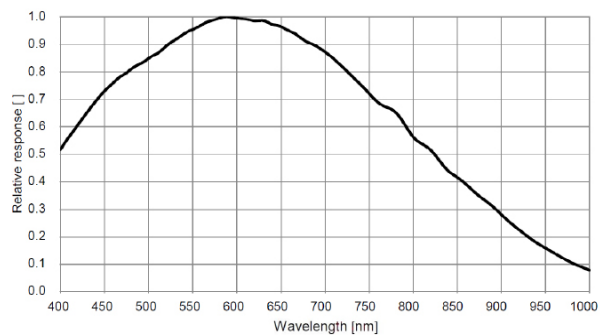

**Lt-C5500**

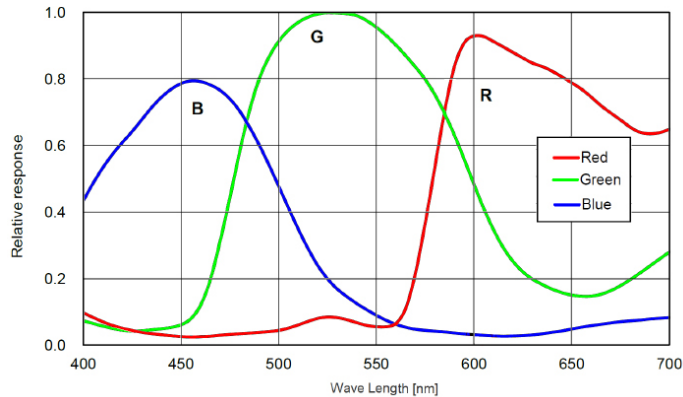

**Lt-M5500**

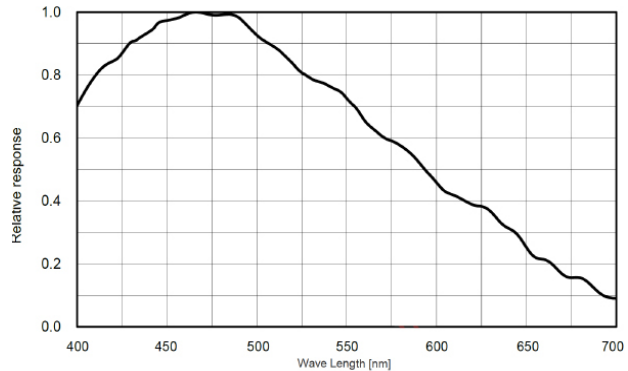

**Lt-C6480, C4430, C5470**

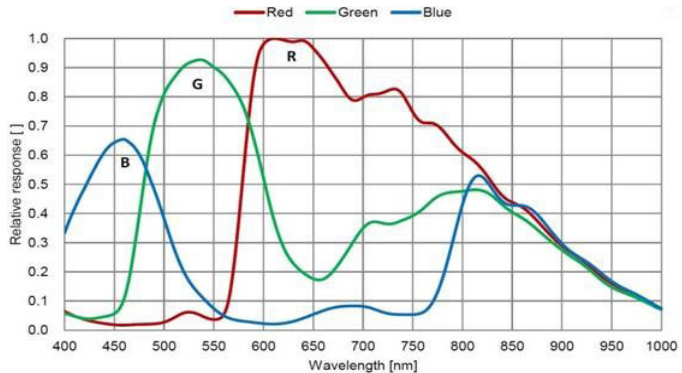

**Lt-M6480, M4430, M5470**

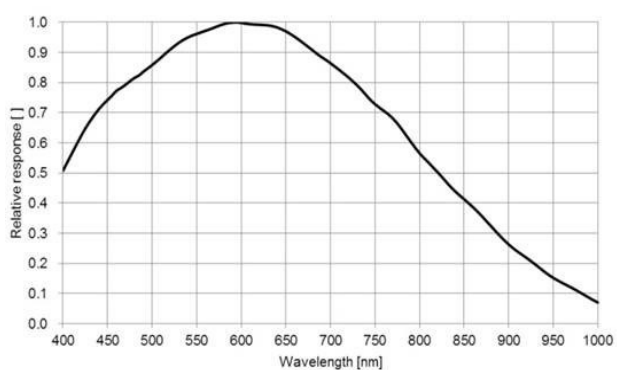

# Lt Camera Series Specifications

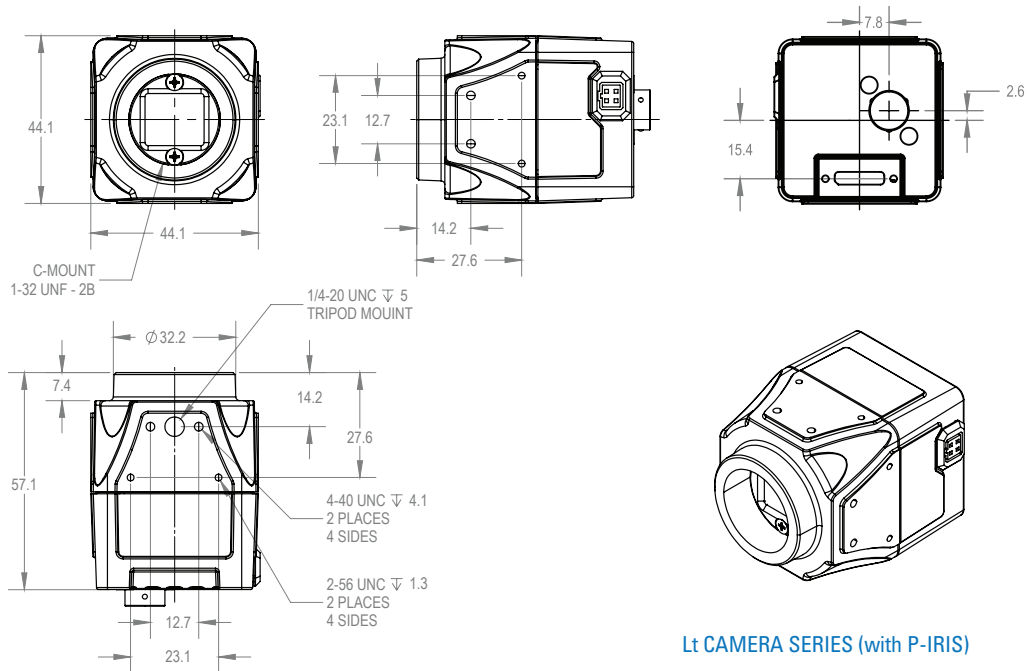

Lt CAMERA SERIES (with P-IRIS)

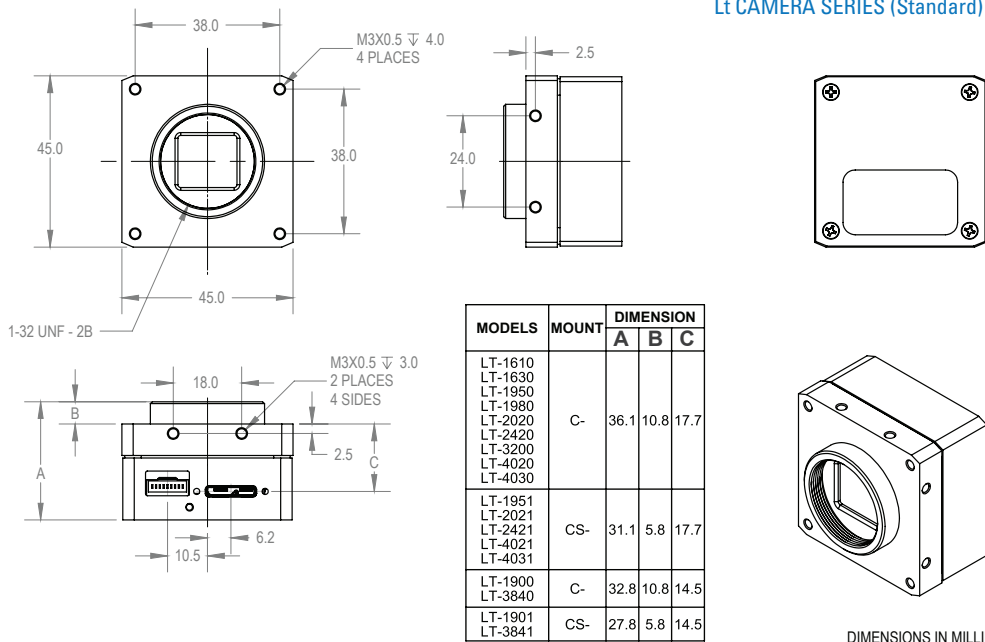

Lt CAMERA SERIES (Standard)

MODELS	MOUNT	DIMENSION		
		A	B	C
LT-1610 LT-1630 LT-1950 LT-1980 LT-2020 LT-2420 LT-3200 LT-4020 LT-4030	C-	36.1	10.8	17.7
LT-1951 LT-2021 LT-2421 LT-4021 LT-4031	CS-	31.1	5.8	17.7
LT-1900 LT-3840	C-	32.8	10.8	14.5
LT-1901 LT-3841	CS-	27.8	5.8	14.5

DIMENSIONS IN MILLIMETERS

[www.teledynevisionsolutions.com](http://www.teledynevisionsolutions.com)

## North America

12051 Riverside Way  
Richmond, BC, Canada  
V6W 1K7  
Phone: +1 866.765.0827 (toll free)

© 2024 Teledyne Lumenera. All rights reserved.  
Design, features, and specifications are subject to change without notice. 12032024



# Lt Camera Series Specifications

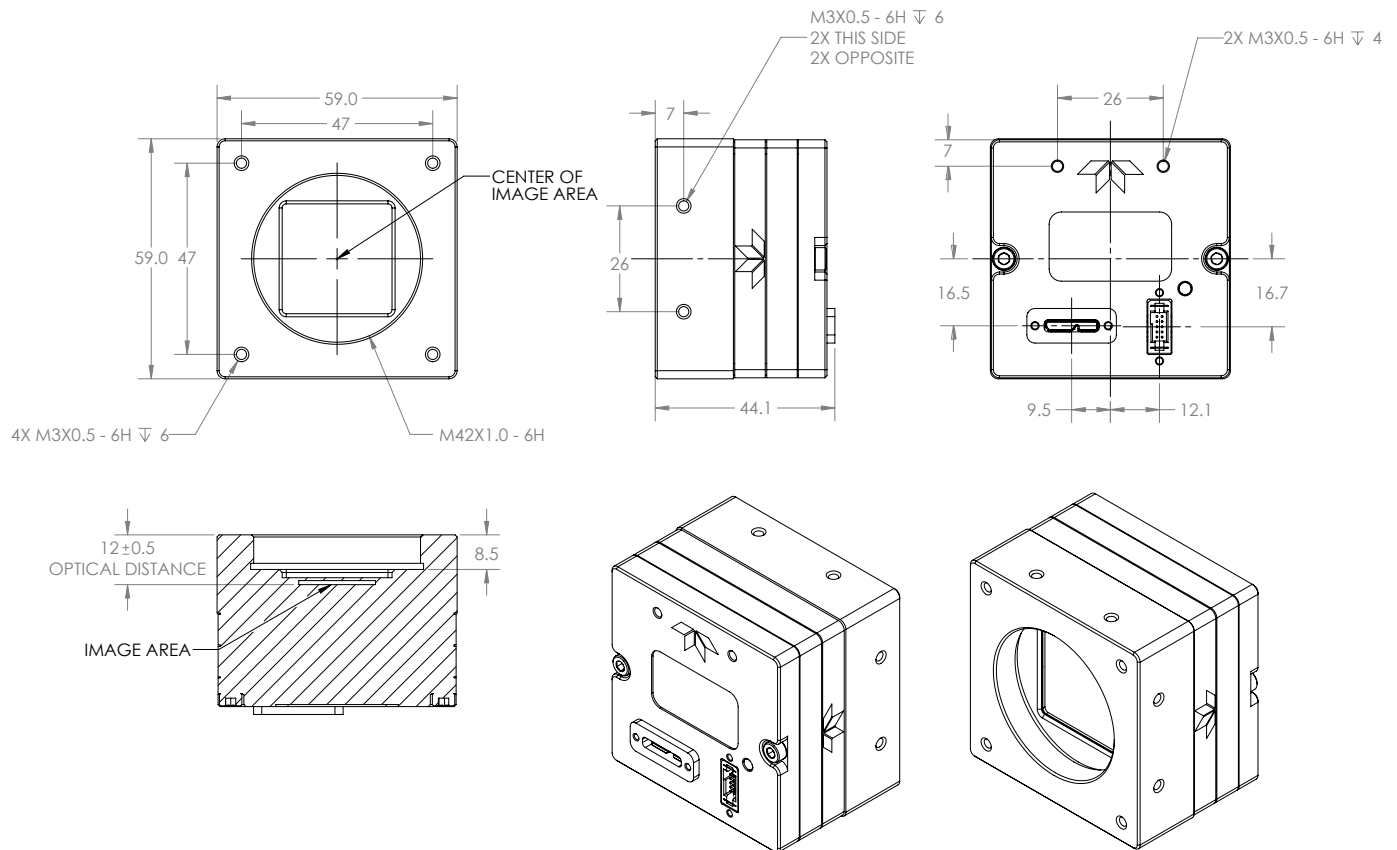

Lt CAMERA SERIES (XL)

[www.teledynevisionsolutions.com](http://www.teledynevisionsolutions.com)

## North America

12051 Riverside Way  
 Richmond, BC, Canada  
 V6W 1K7  
 Phone: +1 866.765.0827 (toll free)

© 2024 Teledyne Lumenera. All rights reserved.  
 Design, features, and specifications are subject to change without notice. 12032024



# Versatile cameras featuring Sony Pregius & Starvis sensors

[www.teledynevisionsolutions.com](http://www.teledynevisionsolutions.com)

**North America**

12051 Riverside Way  
Richmond, BC, Canada  
V6W 1K7  
Phone: +1 866.765.0827 (toll free)

© 2024 Teledyne Lumenera. All rights reserved.  
Design, features, and specifications are subject to change without notice. 12032024