

Lt Series Board Level Cameras

Compact, Lightweight USB3 Cameras Designed for Embedded Systems

Compact and light-weight USB 3 cameras that provided both monochrome and vivid color images for the most demanding environments.

Perfect for embedded systems, Teledyne Lumenera's Lt Series Board Level Cameras offer a smaller, lighter, and lower cost imaging solution. Equipped with the latest advanced Starvis™ and Pregius™ CMOS sensors from Sony®, with a resolution of 2 – 20 megapixels. With connectors on the side of each camera, applications can take advantage of a shorter cable lengths and a flat back design that minimizes the space required for vision systems.

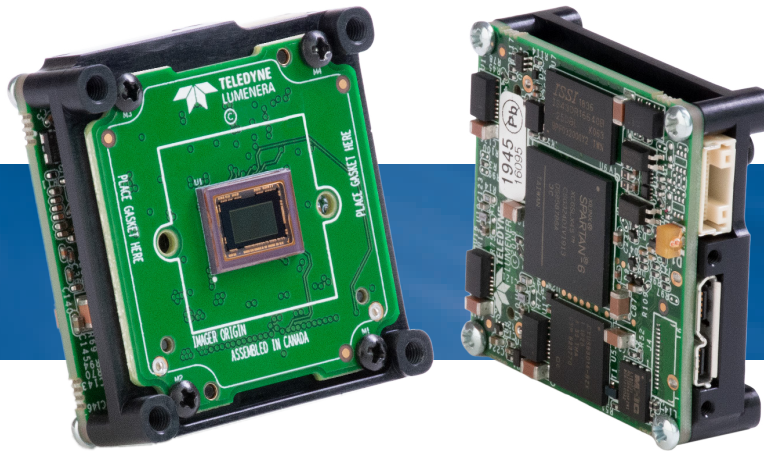

Key Features

Wide selection of advanced Sony Global and Rolling CMOS sensors to meet the diverse requirements of today's embedded vision systems.

Size

Compact board level foot print is ideal for applications where space is tight: UAVs, handheld devices, mobile devices.



















Applications

Ready to meet the challenges of embedded system applications such as aerial imaging, intelligent traffic systems (ITS), robotic inspection, and life sciences.

Compatibility

Flexible, proven 32 and 64-bit operating system compatibility for, Windows, Linux, Linux for embedded system platforms, and single board computers (SBCs).

Lt SERIES BOARD LEVEL CAMERAS SPECIFICATIONS

	Active Resolution	Sensor Model	Frame Rate	Pixel Size	Dynamic Range	Max. Image Circle	Data Format	Part Number**
 Lt-C1610B	1608 x 1104	Sony IMX432 (1.7M)	96 fps	9.00 µm	72.1 dB	1.1" Optical Format	8 or 12-bit	LT-UC11-C161NBL
 Lt-M1610B	1608 x 1104	Sony IMX432 (1.7M)	96 fps	9.00 µm	72.1 dB	1.1" Optical Format	8 or 12-bit	LT-UM11-M161NBL
 Lt-C1630B	1632 x 1248	Sony IMX430 (2.0M)	86 fps	4.50 µm	73 dB	1/1.7" Optical Format	8 or 12-bit	LT-UC11-C163NBL
 Lt-M1630B	1632 x 1248	Sony IMX430 (2.0M)	86 fps	4.50 µm	73 dB	1/1.7" Optical Format	8 or 12-bit	LT-UM11-M163NBL
 Lt-C1900B	1944 x 1096	Sony IMX327 (2.1M) RS*	60 fps	2.90 µm	72.8 dB	1/2.8" Optical Format	8 or 12-bit	LT-UC10-C190NBL
 Lt-C1950B	1936 x 1216	Sony IMX392 (2.3M)	162 fps	3.45 µm	73.27 dB	1/2.3" Optical Format	8 or 12-bit	LT-UC10-C195NBL
 Lt-M1950B	1936 x 1216	Sony IMX392 (2.3M)	162 fps	3.45 µm	73.27 dB	1/2.3" Optical Format	8 or 12-bit	LT-UM10-M195NBL
 Lt-C2020B	2064 x 1544	Sony IMX265 (3.2M)	55 fps	3.45 µm	73.56 dB	1/1.8" Optical Format	8 or 12-bit	LT-UC11-C202NBL
 Lt-M2020B	2064 x 1544	Sony IMX265 (3.2M)	55 fps	3.45 µm	73.56 dB	1/1.8" Optical Format	8 or 12-bit	LT-UM11-M202NBL
 Lt-C2420B	2464 x 2056	Sony IMX264 (5.1M)	35 fps	3.45 µm	73.02 dB	2/3" Optical Format	8 or 12-bit	LT-UC11-C242NBL
 Lt-M2420B	2464 x 2056	Sony IMX264 (5.1M)	35 fps	3.45 µm	73.02 dB	2/3" Optical Format	8 or 12-bit	LT-UM11-M242NBL
 Lt-C3200B	3216 x 2208	Sony IMX428 (7.1M)	50 fps	4.50 µm	73 dB	1.1" Optical Format	8 or 12-bit	LT-UC11-C320NBL
 Lt-M3200B	3216 x 2208	Sony IMX428 (7.1M)	50 fps	4.50 µm	73 dB	1.1" Optical Format	8 or 12-bit	LT-UM11-M320NBL
 Lt-C3840B	3840 x 2160	Sony IMX334 (8.3M) RS*	44 fps	2.00 µm	70.53 dB	1/1.8" Optical Format	8 or 12-bit	LT-UC10-C384NBL
 Lt-M3840B	3840 x 2160	Sony IMX334 (8.3M) RS*	44 fps	2.00 µm	70.53 dB	1/1.8" Optical Format	8 or 12-bit	LT-UM10-M384NBL
 Lt-C4030B	4112 x 2176	Sony IMX267 (8.9M)	31 fps	3.45 µm	73.27 dB	1" Optical Format	8 or 12-bit	LT-UC11-C403NBL
 Lt-M4030B	4112 x 2176	Sony IMX267 (8.9M)	31 fps	3.45 µm	73.27 dB	1" Optical Format	8 or 12-bit	LT-UM11-M403NBL
 Lt-C4020B	4112 x 3008	Sony IMX304 (12M)	22 fps	3.45 µm	73.22 dB	1.1" Optical Format	8 or 12-bit	LT-UC11-C402NBL
 Lt-M4020B	4112 x 3008	Sony IMX304 (12M)	22 fps	3.45 µm	73.22 dB	1.1" Optical Format	8 or 12-bit	LT-UM11-M402NBL

* Rolling Shutter sensors

** For LuCam software compatible part number, please use pn: LT-Lxxx-xxxxxxx

Additional Specifications Across All Models

Data Output Transfer	USB3.1 (5 Gbit/s)
Exposure Control	Manual and automatic control
I/O Ports	Locking connector; includes trigger in, strobe out, and auxiliary power input
Image Buffers	128 MB
Lens Mount	No mount or casing for Board Level Cameras
Size (L x H x W)	40.4 mm x 40.4 mm x 17.1 mm
Mass	28 g
Operating Temp	0 °C to 50 °C
Power Supply	5V via Power Over USB
Power Dissipation (model dependent)	2.3 W to 3.6 W
Data Connector	USB3 Type micro-B (Locking Connector supported)
Power and I/O Connector	JST# SM09B-NSHSS-TB (mating part :JST # NSHR-09V-S)
Camera Specification	USB 3.1 interface , USB3 Vision v1.0 compliant
Software Platform	Teledyne Sopera LT 8.6 for Windows, Lumenera Camera Software Development Kit (LINUX) or 3rd Party GenICam compliant SDK

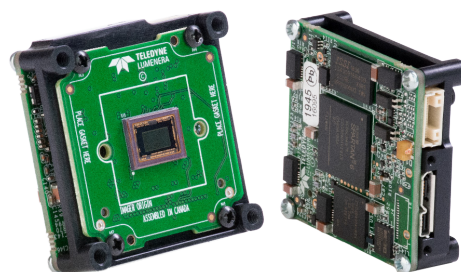

RESPONSIVITY GRAPHS

Lt-C1900B

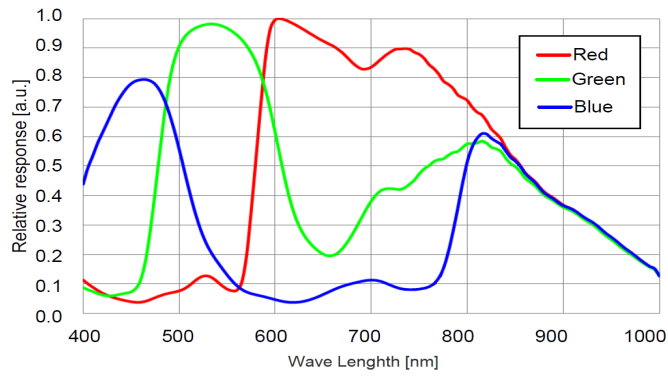

Lt-C3840B

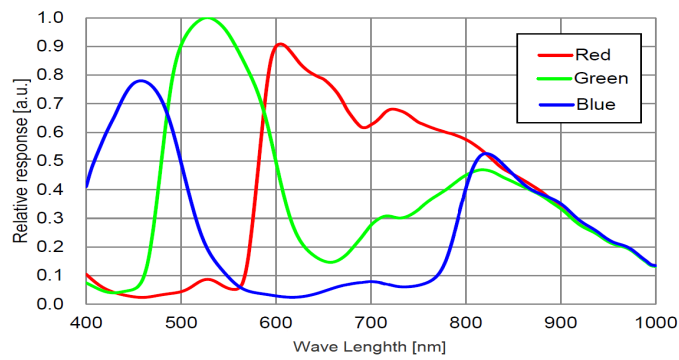

Lt-M3840B

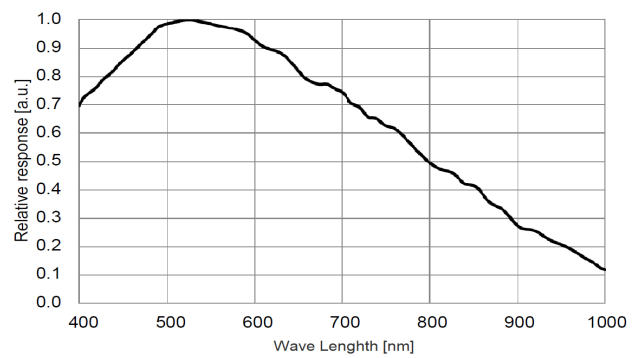

Lt-C1950B, C2020B, C2420B, C4030B, C4020B

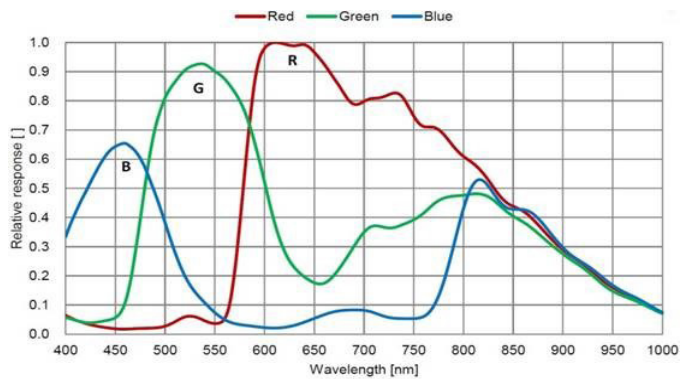

Lt-M1950B, M2020B, M2420B, M4030B, M4020B

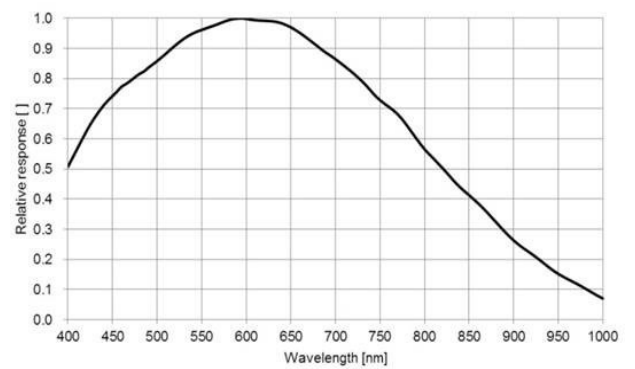

Lt-C1610B, C1630B, C3200B

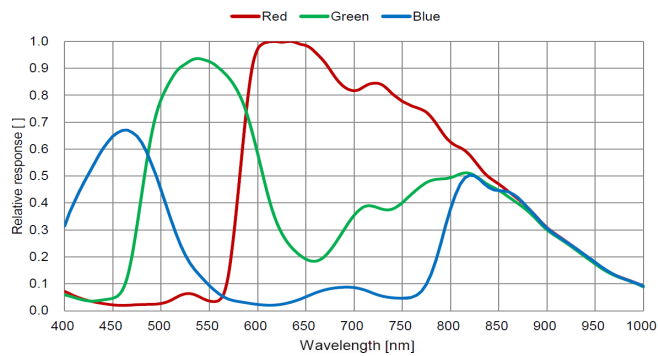

Lt-M1610B, M1630B, M3200B

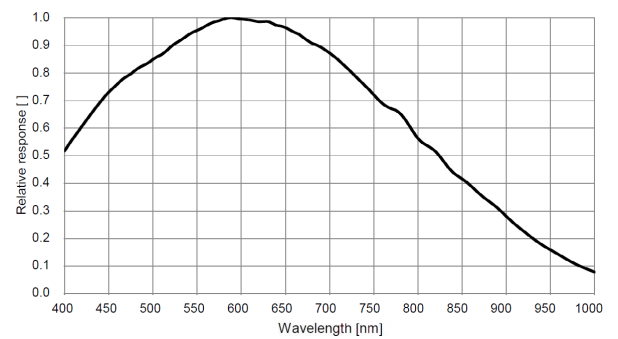

Lt Series Board Level Camera Specifications

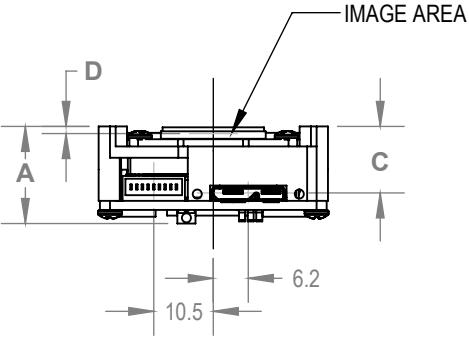
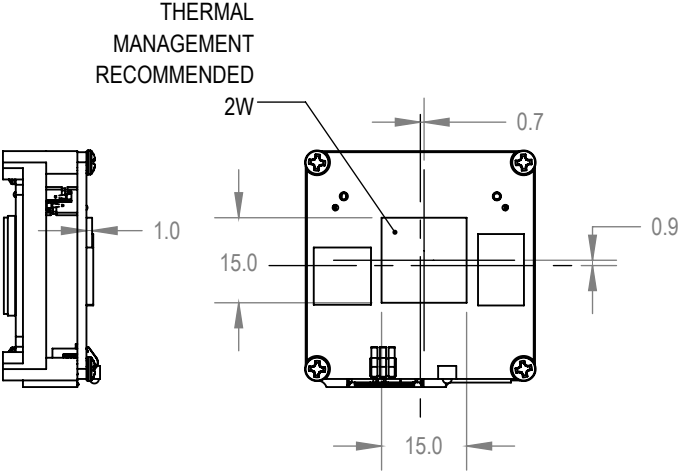
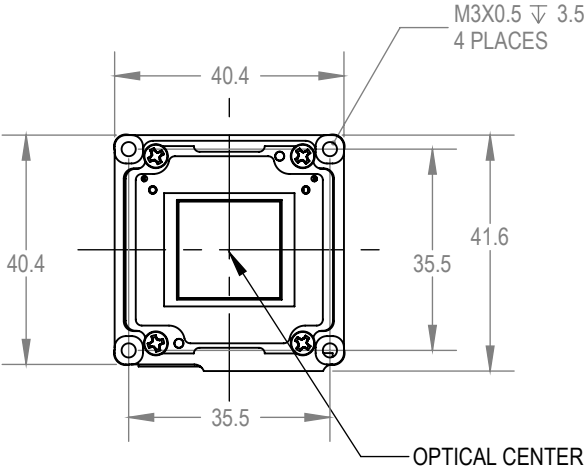

MODELS	DIMENSION		
	A	B	C
LT-1610B	17.1	11.9	1.3
LT-1630B			
LT-1950B			
LT-1980B			
LT-2020B			
LT-2420B			
LT-3200B			
LT-4020B	14.1	8.9	1.6
LT-4030B			
LT-1900B	14.1	8.9	1.6
LT-3840B	14.1	8.9	1.4

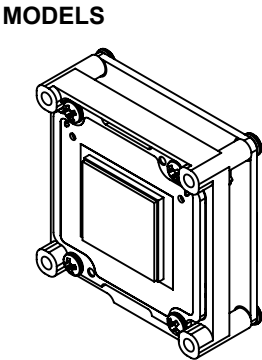

www.teledynelumenera.com

North America
 Ottawa, Canada
 7 Capella Court,
 (TEL) +1 613-736-4077

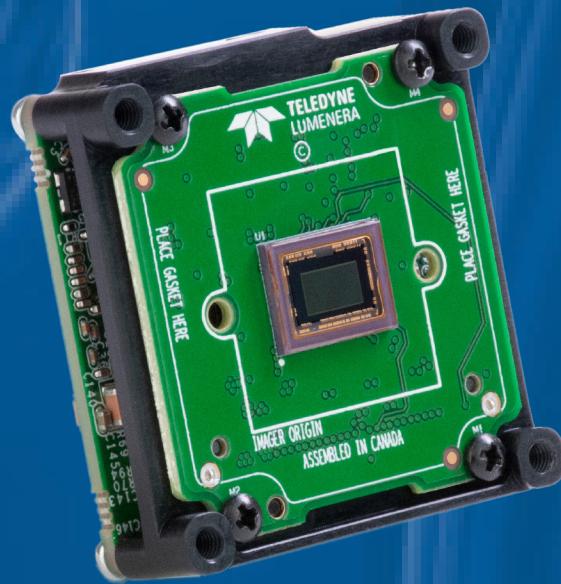

Versatile cameras featuring Sony Pregius & Starvis sensors

www.teledynelumenera.com

North America

Ottawa, Canada
7 Capella Court,
(TEL) +1 613-736-4077

© 2019 Teledyne Lumenera Corporation. All rights reserved.
Design, features, and specifications are subject to change without notice. 30092020

 **TELEDYNE LUMENERA**
Everywhereyoulook™