

Product Highlights

- Built for extreme environments, our IP69K certified lights are specifically engineered to withstand everything from prolonged liquid immersion to high-pressure steam cleaning and corrosive washdown solutions.
- UltraSeal Bar Lights are ideal for hygienic inspection environments, aseptic manufacturing, and food and beverage applications.

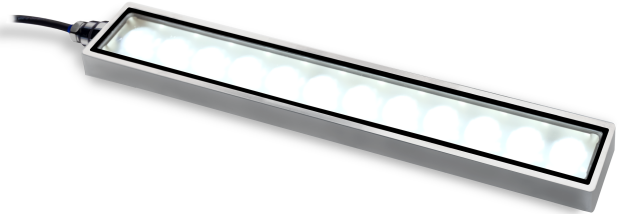

***Patented**

General Specifications

	Color	24V Current	All Other Controls
Electrical Specifications	455, 470, 505, 530, WHI	0.37A per 6 inches	0.35A Max per 6 inches
	590, 625, 660, 730	0.38A per 6 inches	0.30A Max per 6 inches
	850, 940	0.38A per 6 inches	0.20A Max per 6 inches
Normal Operating Temperature	0-60 deg C		
Weight	11.2oz (317.5g) per 6 inches		
Standard Cable Information	2 M long -0/+150 mm (80" -0/+6") - 105°C rated PVC jacket, foil shield with drain		
Photobiological Risk Factor	Exempt Applicable Wavelengths: 850, 940 Group 1 (Low-Risk) Applicable Wavelengths: 455, 470, 505, 530, 590, 625, 666, 730, WHI		
Compliance	CE, RoHS, IEC 62471		
IP Rating	IP69K		
Lumen Maintenance	L70 = 50,000 Hours		

Part Number Key

Model	Lens Type	-	Emitting Length (in)	Peak Wavelength	Connector/ Control	Housing Material	-	Alternative Connector
AL247	X	-	XX	XXX	XX	XX	-	XXX
AL247	N (Narrow)		06	455 (royal blue)	C1	AL (Anodized Aluminum)		M8 ¹
	M (Medium)		12	470 (blue)	C5	SS (Stainless Steel)		M12 ¹
	W (Wide)		18	505 (cyan)	IC			
			24	530 (green)	I3			
				590 (amber)	I3S			
				625 (red orange)	I4			
				660 (red)	24			
				730 (IR)				
				850 (IR)				
				940 (IR)				
				WHI (white)				

Example Part Numbers:
AL247N-06455I3-M12
AL247M-18WHIC1

Beam Angle (FWHM):
Narrow = 8°
Medium = 21°
Wide = 29°

¹Available with IC, I3, I3S, I4 and 24 V options only

Mechanical Specs

LENGTH MATRIX	
CONFIG. (AL247-XX)	MOUNTING HOLE DISTANCE CENTER TO CENTER IN INCHES [mm] (D)
AL247-06	3.94 [100mm]
AL247-12	6.89 [175mm]
AL247-18	9.84 [250mm]
AL247-24*	17.72 [450mm]

AL247-24 HAS ADDITIONAL HOLES AT D/2, DISTANCE BETWEEN HOLES IS 9.84 [225mm]

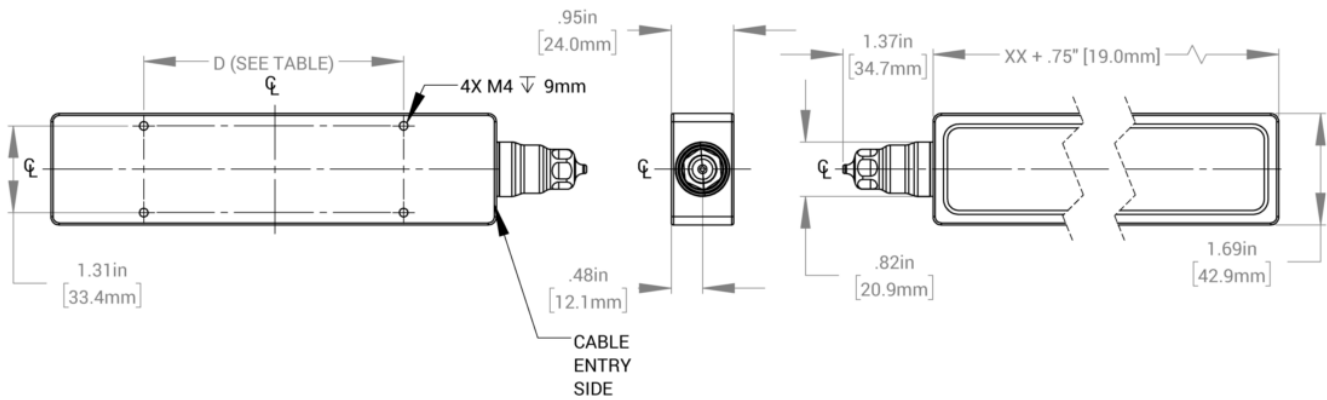

Optical Specs

Intensity Distribution

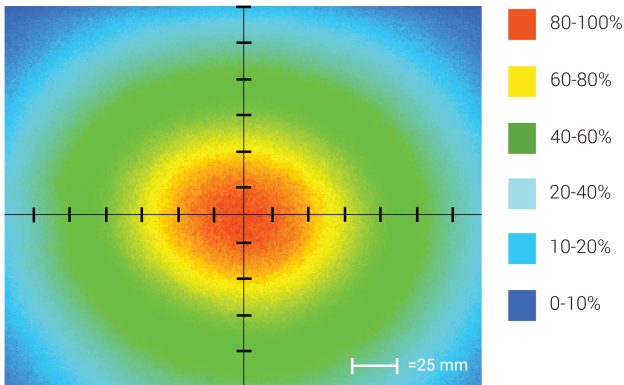

Optical Cone

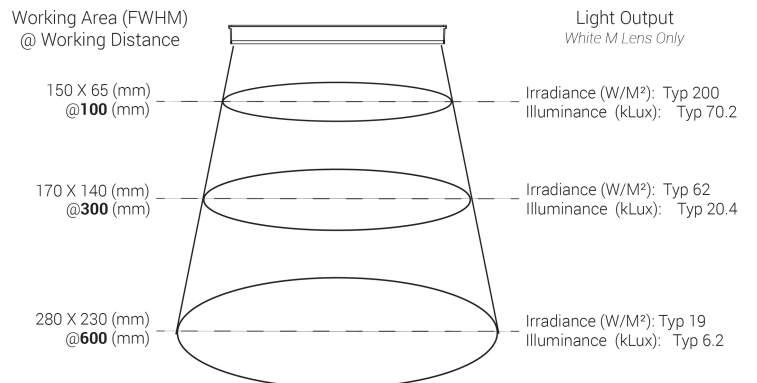

Optical measurement taken using AL247M-06WHII3 @ 300mm

Standard Flying Lead Functions for 24V, IC, I3, I3S, and I4 Control Options

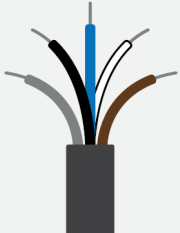

COLOR	24V FUNCTIONS	IC FUNCTIONS	I3/I3S FUNCTIONS	I4 FUNCTIONS
BROWN	24 V DC	24 V DC	24 V DC	24 V DC
WHITE	N/A	0-10 V ANALOG DIMMING	RESERVED	NPN/ACTIVE LOW TRIGGER
BLUE	DC GND	DC GND	DC GND	DC GND
BLACK	N/A	PNP/ACTIVE LOW GATE	PNP/ACTIVE HIGH TRIGGER	PNP/ACTIVE HIGH TRIGGER
GRAY	N/A	N/A	0-10 V ANALOG DIMMING	0-10 V ANALOG DIMMING

The functions listed above are applicable when this product is configured with built-in 24V, IC, I3, I3S, or I4 control, without the optional A-coded 5-position Male M12 or A-coded 4-position Male M8 connector.

M12 Connector Pinout Functions for 24V, IC, I3, I3S, and I4 Control Options

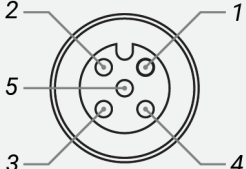

PIN	24V FUNCTIONS	IC FUNCTIONS	I3/I3S FUNCTIONS	I4 FUNCTIONS
1	24 V DC	24 V DC	24 V DC	24 V DC
2	N/A	0-10 V ANALOG DIMMING	RESERVED	NPN/ACTIVE LOW TRIGGER
3	DC GND	DC GND	DC GND	DC GND
4	N/A	PNP/ACTIVE LOW GATE	PNP/ACTIVE HIGH TRIGGER	PNP/ACTIVE HIGH TRIGGER
5	N/A	N/A	0-10 V ANALOG DIMMING	0-10 V ANALOG DIMMING

The functions listed above are only applicable when this product is configured with built-in 24V, IC, I3, I3S, or I4 control, with an A-coded 5-position Male M12 connector.

M8 Connector Pinout Functions for 24V, IC, I3, I3S, and I4 Control Options

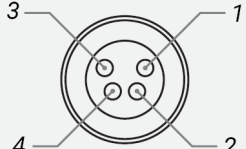

PIN	24V FUNCTIONS	IC FUNCTIONS	I3/I3S FUNCTIONS	I4 FUNCTIONS
1	24 V DC	24 V DC	24 V DC	24 V DC
2	N/A	0-10 V ANALOG DIMMING	0-10 V ANALOG DIMMING	0-10 V ANALOG DIMMING
3	DC GND	DC GND	DC GND	DC GND
4	N/A	PNP/ACTIVE LOW GATE	PNP/ACTIVE HIGH TRIGGER	PNP/ACTIVE HIGH TRIGGER

The functions listed above are only applicable when this product is configured with built-in 24V, IC, I3, I3S, or I4 control, with an A-coded 4-position Male M8 connector.

For details on operating configurations without built-in control (C1, C5, Q1, and Q4 control, when available), please refer to Advanced illumination's controller manuals.

Control Specs

<p>C1 CONNECTOR</p> <p>For use with: DCS Series Controllers</p> <p>Strobe/Continuous Controllers</p>	<p>C5 CONNECTOR</p> <p>For use with: Pulsar 320</p> <p>High Power Strobe only Controller</p>	<p>ICS 2 (IC)</p> <p>In-line Continuous Controller</p> <p>Powered with: 24V Power Supply</p>	<p>ICS 3</p> <p>In-line Strobe/ Continuous Controller</p> <p>Default On</p> <p>Powered with: 24V Power Supply</p>
<p>ICS 3S (I3S)</p> <p>In-line Strobe/ Continuous Controller</p> <p>Default Off</p> <p>Powered with: 24V Power Supply</p>	<p>I4</p> <p>In-line Strobe/ Continuous Controller</p> <p>Powered with: 24V Power Supply</p>	<p>24 VOLT</p> <p>Flying/Tinned Leads</p> <p>Powered with: 24V Power Supply</p>	

Warranty Information

Every Advanced illumination, Inc. (Ai) product is thoroughly inspected and tested before leaving the factory. Products are warranted to be free of defects in workmanship and materials for a period of FIVE YEARS from the original date of purchase. Should a defect develop during this period, customers may return the complete product, freight prepaid, to one of Ai's distributors or to the Ai factory. All product warranty returns require a Return Merchandise Authorization (RMA) number which is obtained from Customer Service. The RMA number must be clearly marked on the outside of the package. Ai will inspect the unit, and if a defect is found will, at our option, repair or replace the product without charge. Ai disclaims liability for any implied warranties, including implied warranties of "merchantability" and "fitness for a specific purpose." For products under warranty that have since been discontinued, Ai will make an effort to replace with equivalent parts; for circumstances that do not allow for equivalent replacement, Ai reserves the right to repair or replace these products with an updated version. Ai cannot be held responsible for the unauthorized or inappropriate use of its products. Any unauthorized repair or modifications will result in a voided warranty.

No Liability for Consequential Damages: In no event shall Ai be liable for any consequential, special, incidental, or indirect damages of any kind arising from the sale or use of the products.

Electromagnetic Compatibility

This product was tested and complies with the regulatory requirements and limits for electromagnetic compatibility (EMC) as stated in the product specifications. These requirements and limits are designed to provide reasonable protection against harmful interference only when the product is operated in its intended industrial electromagnetic environment. To minimize the potential for electromagnetic interference or unacceptable performance degradation, install and use this product in strict accordance with the instructions in the product documentation.

Customer Service

For information on existing orders, or to make an order adjustment, contact us Monday through Friday 8:00 am to 5:00 pm ET or send an email to orders@advancedillumination.com.

Company Information

Advanced Illumination

440 State Garage Road, Rochester, VT 05767

Phone: 802.767.3830

Fax: 802.767.2636

Email: info@advancedillumination.com

Web: advancedillumination.com

© 2021 Advanced illumination Inc. All rights reserved