



FRIWO[®]

Gebrauchsanleitung

Ladegeräte

Instruction Manual

Charger

FW 7118, 7218, 7219, 7290, 7300, 7304,
7310, 7318, 7574, 8100, 8101, 8102,
8103, 8103/DT, 8104, 8105, 8106, 8113



FRIWO Gerätebau GmbH
Von-Liebig Straße 11
D-48346 Ostbevern
Germany



1852648 | V 04 | 2018.09





INHALT **DEUTSCH**

ZU IHRER SICHERHEIT	4
BESTIMMUNGSGEMÄSSE VERWENDUNG	8
ANSCHLUSS ADAPTER	10
PFLEGE.....	16
STÖRUNGSBESEITIGUNG	17
ENTSORGUNG	17
BETRIEBSANZEIGE	18
BETRIEBSANZEIGE	19
TECHNISCHE DATEN TECHNICAL DATA	38
MONTAGE MOUNTING.....	40
GEBRAUCHSLAGE POSITION OF USE	43



CONTENT **ENGLISH**

FOR YOUR SAFETY	21
DESIGNATED USE.....	25
CONNECTING OF ADAPTER	27
MAINTENANCE.....	33
FAULT CORRECTION	34
DISPOSAL.....	34
OPERATING INDICATOR	35
TECHNISCHE DATEN TECHNICAL DATA	38
MONTAGE MOUNTING.....	40
GEBRAUCHSLAGE POSITION OF USE	43



DEUTSCH

ZU IHRER SICHERHEIT



Gebrauchsanleitung lesen

Diese Gebrauchsanleitung enthält Informationen für den sicheren Umgang mit den auf der Titelseite aufgeführten Ladegeräten. Sie zeigt die Montage der Netz- und Sekundäradapter des Ladegerätes.

- Erst die Gebrauchsanleitung lesen, dann das Ladegerät verwenden.
- Die Gebrauchsanleitung gehört zum Produkt und muss stets verfügbar sein.
- Abbildungen in dieser Gebrauchsanleitung zeigen Funktionen beispielhaft und können vom tatsächlichen Aussehen des Ladegerätes abweichen.



Personenschaden vermeiden

- Ladegerät niemals bei beschädigtem Gehäuse oder beschädigter Leitung verwenden.
- Ladegerät niemals modifizieren oder das Gehäuse öffnen.
- Ladegerät nur an einer vorschriftsmäßigen Steckdose anschließen.
- Steckverbindungen vor Feuchtigkeit schützen.





Sachschaden vermeiden

- Ladegerät niemals an der elektrischen Leitung tragen oder ziehen.
- Nur am Stecker ziehen, um eine Steckverbindung zu lösen, niemals an der Leitung.
- Leitungen geschützt verlegen und darauf achten, dass niemand darüber fallen kann.
- Ladegerät bei Gewitter vom Stromnetz trennen.
- Nur Original-Ersatzteile oder -Zubehör von FRIWO verwenden.



Symbole auf dem Gerät beachten

Symbole zu Ihrer Sicherheit und zum Schutz der Umwelt:

	Bedienungsanleitung lesen.
	Expositionsbedingungen für den Innenbereich
	Gerät der Schutzklasse II AC-Eingang und DC-Ausgang sind elektrisch sicher ge- trennt.
	Nur in geschlossenen Räu- men verwenden.
	Ladegerät über das dafür vorgesehene Rücknahmesys- tem entsorgen.



Zu Ihrem eigenen Schutz und zu Schutz Ihres Ladegerätes beachten Sie alle Hinweise in dem Text, die mit diesem Symbol gekennzeichnet sind!



Das Gerät entspricht dem California Code of Regulations Title 20 Standard.





BESTIMMUNGSGEMÄSSE VERWENDUNG

- Dieses Ladegerät darf nur für den auf dem Typenschild angegebenen Akku verwendet werden
- Trennen Sie das Ladegerät vom Netz bevor Sie die Verbindung zum Akku herstellen oder unterbrechen
- Niemals andere als auf dem Typenschild angegebene Akkus oder nicht wieder aufladbare Batterien laden. Dies kann zum Aufplatzen der Akkus, zur Explosion und/oder Verletzung des Anwenders führen
- Beim Anschluss an Stromnetze (**AC**-Eingang) sowie am **DC**-Ausgang zum Akku, ist auf die Kompatibilität der technischen Daten des Ladegerätes zu achten.
- Alle angeschlossenen Akkus müssen mit einer integrierten Sicherheitsschaltung ausgestattet sein
- Nur zur Verwendung in geschlossenen Räumen.
- Betrieb nur bei zulässigen Umgebungsbedingungen, Temperatur, Luftdruck und Luftfeuchtigkeit. → TECHNISCHE DATEN





Einschränkungen für alle Ladegeräte:

- Nicht im Freien verwenden.
- Nicht in Wasser oder andere Flüssigkeiten tauchen.
- Nicht am Wasser betreiben.
- Von Spritzwasser fernhalten.
- Nicht erlaubte Umgebungsbedingungen:
 - Ständige Vibrationen.
 - Starke Temperaturschwankungen.



Lebensgefahr durch Stromschlag!



Ladegerät nur in trockener Umgebung verwenden.
Spritzwasser vermeiden. Niemals in Flüssigkeiten tauchen.





ANSCHLUSS ADAPTER

AC-Eingang (Netzanschluss):

FW 8100, 8101, 8102, 8103/DT, 8113	Lader mit C8-Adapter. → MONTAGE
FW 7118, 7574	Lader mit integriertem Netzadapter für unterschiedliche Regionen.
FW 7218, 7219, 7290, 7300, 7304, 7310, 7318, 8103, 8104, 8105, 8106	Lader mit austauschbarem Netzadapter für unterschiedliche Regionen. → MONTAGE





HINWEIS

FW 8103, 8104, 8105, 8106

Schutz gegen fallendes Tropfwasser (IP42)!

- nur mit aufgestecktem Sonderzubehör:
IP42 Netzadapter → MONTAGE
- Gebrauchslage beachten → GEBRAUCHSLAGE

WARNUNG

Lebensgefahr durch Stromschlag, bei Beschädigung der Netzleitung!

- Das Netzkabel kann nicht ersetzt werden. Wenn das Kabel beschädigt ist, sollte das Gerät verschrottet werden.





DC-Ausgang:

An der Buchse des DC-Ausgangs sind verschiedene Sekundäradapter (Koaxialstecker oder Klinkenstecker) anschließbar. Die Polarität wird durch Drehen des Steckers eingestellt. → MONTAGE

HINWEIS

Ein Vertauschen der Polarität (Plus und Minus) kann die Elektronik des angeschlossenen Gerätes beschädigen!

- Vor Herstellen der Steckverbindung Markierung für die Polarität auf dem Stecker beachten.

→ MONTAGE

HINWEIS

Die Verbindung von Sekundäradapter und Ladegerät ist nicht mehr lösbar!

- Steckverbindung nur herstellen, wenn Stecker dauerhaft montiert werden soll.





HINWEIS

Dieses Gerät kann von Kindern ab 8 Jahren und darüber sowie von Personen mit verringerten physischen, sensorischen oder mentalen Fähigkeiten oder Mangel an Erfahrung und Wissen benutzt werden, wenn sie beaufsichtigt oder bezüglich des sicheren Gebrauchs des Gerätes unterwiesen wurden und die daraus resultierenden Gefahren verstehen. Kinder dürfen nicht mit dem Gerät spielen. Reinigung und Benutzer-Wartung dürfen nicht von Kindern ohne Beaufsichtigung durchgeführt werden.



HINWEIS

Dieses Gerät ist nicht dafür bestimmt, durch Personen (einschließlich Kinder) mit eingeschränkten physischen, sensorischen oder geistigen Fähigkeiten oder mangels Erfahrung und / oder mangels Wissen benutzt zu werden, es sei denn, sie werden durch eine für ihre Sicherheit zuständige Person beaufsichtigt oder erhielten von ihr Anweisungen, wie das Gerät zu benutzen ist. Kinder sollten beaufsichtigt werden, um sicherzustellen, dass sie nicht mit dem Gerät spielen.





 WARNUNG

Strangulationsgefahr, wenn ein Baby oder Kind sich in die Anschluß- oder Ausgangsleitung verwickelt!

- Halten Sie die Leitungen außerhalb der Reichweite von Babys oder Kindern.

 WARNUNG

Die Verwendung von anderen Leitungen oder Adaptern als von Friwo festgelegt oder bereitgestellt, kann erhöhte elektromagnetische Störaussendungen oder eine geminderte elektromagnetische Störfestigkeit des Geräts zur Folge haben und zu einer fehlerhaften Betriebsweise führen!





 WARNUNG

Die Verwendung des Ladegeräts neben oder in Verbindung mit anderen Geräten sollte vermieden werden, da dies zu Fehlfunktionen im Betrieb führen kann. Wenn eine solche Verwendung erforderlich ist, sollten dieses Gerät und die anderen Geräte beobachtet werden, um sicherzustellen, dass sie normal funktionieren!

 WARNUNG

Elektrische Geräte können die Funktion oder Leistung des Ladegerätes beeinträchtigen!

- Andere elektrische Geräte nicht neben, auf oder unter das Ladegerät stellen.
- Tragbare HF-Kommunikationsgeräte (einschließlich Peripheriegeräte wie Antennenkabel und externe Antennen) sollten nicht näher als 30 cm (12 Zoll) an einem Teil des Ladegeräts verwendet werden, einschließlich der vom Hersteller angegebenen Kabel.





PFLEGE

Keine chemischen Reinigungsmittel verwenden.

WARNUNG

Lebensgefahr durch Stromschlag, wenn Flüssigkeit in das Innere des Ladegerätes gelangt!

- Vor dem Reinigen Ladegerät vom Netz trennen.
- Keine Flüssigkeiten zum Reinigen verwenden.
- Ladegerät nur trocken abwischen.





STÖRUNGSBESEITIGUNG

Das Ladegerät ist wartungsfrei. Bei defektem Ladegerät oder bei Störungen, die sich nicht beheben lassen, den Händler oder FRIWO kontaktieren.

ENTSORGUNG

HINWEIS



Umweltschäden durch falsche Entsorgung!

- Ladegerät durch Abschneiden der Leitung unbrauchbar machen und über das dafür vorgesehene Rücknahmesystem entsorgen.





BETRIEBSANZEIGE

(FW 7219, 7290, 7300, 7310)

LED leuchtet (gelb)	Bereitschaft
LED blinkt alternierend (gelb & grün)	Akku außerhalb des Temperaturbereichs (warten)
LED blinkt (gelb)	Vorladung
LED blinkt schnell (grün)	Hauptladung
LED blinkt langsam (grün)	Nachladen
LED Leuchtet (grün)	Ladevorgang abgeschlossen
LED blinkt schnell (gelb)	Fehler



BETRIEBSANZEIGE

(FW 7218, 7318)

LED leuchtet (gelb)	Ladung
LED leuchtet (grün)	Ladevorgang abgeschlossen (Nachladen)





BETRIEBSANZEIGE

(FW 7118, 7574)

LED leuchtet (grün)	Bereitschaft
LED leuchtet (gelb)	Ladung
LED leuchtet schwach (grün)	Ladevorgang abgeschlossen (Nachladen)
LED leuchtet nicht	Akku tiefentladen oder Kurzschluss Zu hohe Akkuspannung Verpolung



BETRIEBSANZEIGE

(FW 7304)

LED blinkt schnell (rot)	Vorladung
LED leuchtet (rot)	Hauptladung
LED blinkt langsam (rot)	Ladevorgang abgeschlossen (Nachladen)



BETRIEBSANZEIGE

(FW 8100, 8101, 8102, 8103, 8103DT,
8104, 8105, 8106, 8113)

LED Abfolge (gelb → grün → aus) ---	Standby: Initialisierung/Bereitschaft
LED blinkt (grün) --	Charge: Vor-, Haupt-, Nachladung
LED leuchtet (grün) —	Ready: Ladevorgang abgeschlossen
LED blinkt * (gelb / grün) --	Repair: Akku tiefentladen (warten)
LED leuchtet * (gelb) —	Wait: Akku außerhalb des Temperaturbereichs (warten)
LED leuchtet ** (rot) —	Error: Fehler

* Befindet sich die Batterietemperatur bzw. die Batteriespannung wieder im angegebenen Arbeitsbereich, führt das Ladegerät das Laden automatisch fort.

** Nach Behebung der Fehlerbedingung ist ein Neustart durch Netztrennung erforderlich.

ENGLISH

FOR YOUR SAFETY



Read instruction manual

This manual contains information for the safe handling of those chargers which are listed on the front page.

It explains the installation of the mains and secondary adapters of the charger.

- Always read the instruction manual first before using the charger.
- The instruction manual is part of the product and should always be available.
- Illustrations show functions by way of example and may differ from the actual look of the charger.



Prevent shock-hazard

- Never use a charger with damaged housing or cable.
- Never modify a charger or open its housing.
- Connect the charger to a regular outlet only.
- Protect connectors from moisture.







Prevent property damage

- Never carry the charger by its electrical cable or pull at the cable.
- For separating the connection always pull on the plug, never on the cable.
- Cables must be installed safely to avoid tripping over.
- Disconnect the charger during thunderstorms.
- Only use original FRIWO spare parts or accessories.



Observe all symbols

Symbols for your safety and for environmental protection

	Read instruction manual
	Exposure conditions for indoor use
	Units with protection class II AC input and DC output are electrically safely isolated
	Indoor use only.
	Dispose the charger via the designated take-back system
	For your own protection and for the protection of your charger pay attention to all parts of the text that are marked with this symbol!



 The device complies with the California Code of Regulations Title 20 Standard.





DESIGNATED USE

- This charger may only be used for the batteries specified on the marking plate
- Disconnect the battery charger from mains voltage before connecting or disconnecting the battery
- Never try to charge non rechargeable batteries or other types of batteries then mentioned on the marking plate. This may cause damage to the batteries such as crack, explosion and/or injuries to the user
- For the connection to power grids (**AC** input) and the **DC** output to the battery, take care of the compatibility with the technical characteristics of the charger.
- All connected battery packs have to be equipped with an integrated safety circuit
- For indoor use only.
- Use only at permissible ambient conditions, temperature, Atmospheric pressure and humidity. → TECHNICAL DATA





Restrictions for all chargers:

- Never use outdoors.
- Never immerse in water or other fluids.
- Never use near water.
- Protect from spray water
- Prohibited environmental conditions:
 - Constant vibrations.
 - Radical changes in temperature.



Danger of fatal electric shock!
Use charger in dry environment only. Avoid splash-
ing water. Do not immerse in liquids.





CONNECTING OF ADAPTER

AC input (mains adapter):

FW 8100, 8101, 8102, 8103/DT, 8113	Charger with C8-adapter → MOUNTING
FW 7118, 7574	Charger with integrated mains adapter for different regions.
FW 7218, 7219, 7290, 7300, 7304, 7310, 7318, 8103, 8104, 8105, 8106	Charger with interchangeable mains adapter for different regions. → MOUNTING





NOTE

FW 8103, 8104, 8105, 8106

Protection against vertically dripping water (IP42)!

- only with mounted special IP42 interchangeable mains adapter → MOUNTING
- Consider Position of use → POSITION OF USE



WARNING

Risk of lethal electric shock if the supply cord is damaged!

- The supply cord cannot be replaced. If the cord is damaged the appliance should be scrapped.





DC Output:

Different secondary adapters (coax plugs or jacks) can be connected to the DC output. The polarity is set by rotating the plug. → MOUNTING

NOTE

Reversed polarity (plus and minus) can damage the electronics of the connected device!

- Observe polarity signs on the plug prior to connecting. → MOUNTING



NOTE

The combination of secondary adapter and charger can not be disconnected!

- Connect only when plug is to be permanently mounted.





NOTE

This appliance can be used by children aged from 8 years and above and persons with reduced physical, sensory or mental capabilities or lack of experience and knowledge if they have been given supervision or instruction concerning use of the appliance in a safe way and understand the hazards involved. Children shall not play with the appliance. Cleaning and user maintenance shall not be made by children without supervision.



NOTE

This appliance is not intended for use by persons (including children) with reduced physical, sensory or mental capabilities, or lack of experience and knowledge, unless they have been given supervision or instruction concerning use of the appliance by a person responsible for their safety. Children should be supervised to ensure that they do not play with the appliance.





! WARNING

Risk of Strangulation when a baby or child is involved in the charger cable!

- Keep the input and output cables out of reach of babies or children.

! WARNING

Use of cables or adapters other than those specified or provided by Friwo could result in increased electromagnetic emissions or decreased electromagnetic immunity of this equipment and result in improper operation!





 WARNING

Use of charger adjacent to or stacked with other equipment should be avoided because it could result in improper operation. If such use is necessary, this equipment and the other equipment should be observed to verify that they are operating normally!

 WARNING

Electric equipment can significantly impact the performance of the charger!

- Do not place other electric equipment close to the charger.
- Portable RF communications equipment (including peripherals such as antenna cables and external antennas) should be used no closer than 30 cm (12 inches) to any part of the charger, including cables specified by the manufacturer. Otherwise, degradation of the performance of this equipment could result.





MAINTENANCE

Do not use chemical cleaning agents.

WARNING

Risk of lethal electric shock if fluid leaks into the charger!

- Disconnect charger before cleaning.
- Do not use fluids for cleaning.
- Wipe with a dry cloth only.





FAULT CORRECTION

The charger is maintenance-free. In case of a faulty charger or malfunctions that can not be solved, please contact the dealer or FRIWO.

DISPOSAL

NOTE



Environmental contamination caused by incorrect disposal!

- Cut off the cable of the charger and dispose the unit via the designated take-back system. → MOUNTING





OPERATING INDICATOR

(FW 7219, 7290, 7300, 7310)

LED permanent on (yellow)	Standby
LED flashing alternate (yellow & green)	Battery outside of temperature range (wait)
LED slow flashing (yellow)	Pre charge
LED fast flashing (green)	Main charge
LED slow flashing (green)	Re charge
LED permanent on (green)	Charge complete
LED fast flashing (yellow)	Error



OPERATING INDICATOR

(FW 7218, 7318)

LED permanent on (yellow)	Charge
LED permanent on (green)	Charge complete (Re charge)



OPERATING INDICATOR

(FW 7118, 7574)

LED permanent on(green)	Standby
LED permanent on (yellow)	Charge
LED dimmed (green)	Charge complete (Re charge)
LED off	Battery deep dis- charged or short cut High battery Voltage Reversed battery

OPERATING INDICATOR

(FW 7304)

LED fast flashing (red)	Pre charge
LED flashing (red)	Main charge
LED slow flashing (red)	Charge complete (Re charge)

OPERATING INDICATOR

**(FW 8100, 8101, 8102, 8103, 8103DT,
8104, 8105, 8106, 8113)**

LED sequence (yellow → green → off) ---	Standby: Initialization/ Ready for use
LED flashing (green) --	Charge: Pre-, Main-, Recharge
LED constant on (green) —	Ready: Charge complete
LED flashing alternate * (yellow / green) --	Repair: Deep-discharged battery (wait)
LED constant on * (yellow) —	Wait: Battery outside of temperature range (wait)
LED constant on ** (red) —	Error: Error

*When the temperature or the battery voltage is in operation range again, the charger will automatically continue with charging.

**After removing the error condition, a disconnection from supply is required to exit the error mode.

TECHNISCHE DATEN | TECHNICAL DATA

Allgemein | General

Umgebungstemperatur im Betrieb Ambient temperature during operation	0 ... +40 °C
Lagertemperatur Storage temperature	-20 ... +70 °C
Luftfeuchtigkeit Humidity	≤90%, nicht kondensierend non-condensing
Schutzart Protection rating	IP 40
Schutzklasse Protection class	II
Luftdruck Atmospheric pressure	70-106 kPa
Max. Betriebshöhe Max. altitude of operation	2000 m

Elektrisch | Electrical

siehe Aufdruck auf dem Ladegerät | see printing on charger



Ausnahmen | Exceptions:

FW 7218, 7318,



Lagertemperatur Storage temperature	-40 ... +70 °C
--	----------------

**FW 7118, 7218, 7219, 7290, 7300, 7304, 7310,
7318, 7574**



Luftfeuchtigkeit Humidity	≤95%, nicht kondensierend non-condensing
-----------------------------	--

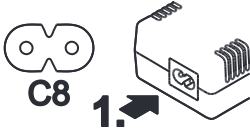
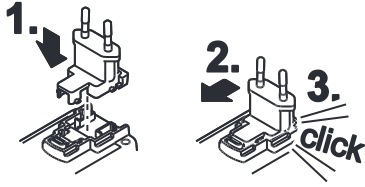

MONTAGE | MOUNTING

AC	
FW 8100, 8101, 8102, 8103/DT, 8113	
FW 7290, 7300, 7310	
	

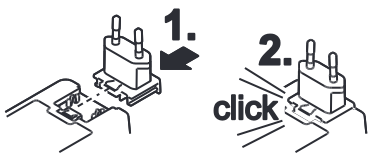
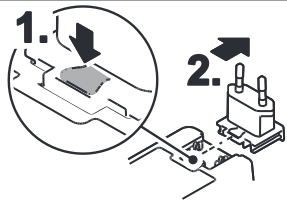

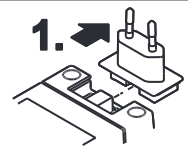
AC	
FW 8103, 8104, 8105, 8106	
	
FW 7218, 7219, 7304, 7318	
	





DC

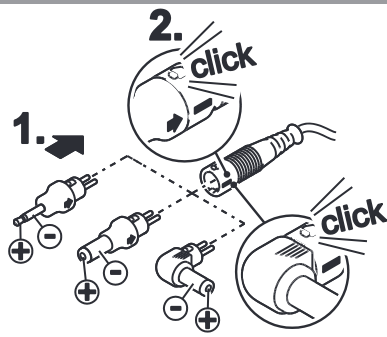
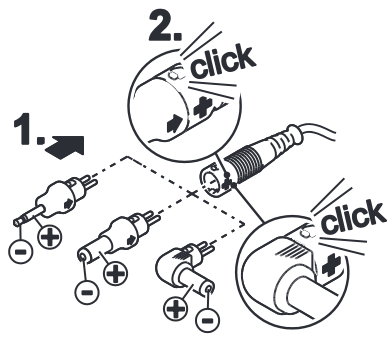

GEBRAUCHSLAGE | POSITION OF USE

Für Schutz gegen Fallendes Tropfwasser (IP42) |
For protection against vertically dripping water
(IP42)

<p>FW 8103, 8104, 8105, 8106</p>	<p>Waagrecht /<i>Horizontal</i></p> 
<p>mit IP42 Netzadapter with IP42 interchangea- ble mains adapter</p>	<p>Senkrecht (Leitung nach unten)/ Vertical (lead outled down)</p> 